



Intellicare
FURNITURE

Intellicare Furniture Long Term Care and Assisted Living Price Guide



Solutions for the Healthcare Community

Commitment to Quality

Intellicare Furniture is designed to be the most durable and adaptable furniture used by healthcare professionals anywhere. Fabricated using commercial grade materials, our products are built to handle the rigours of everyday use in the healthcare industry. All of our products are proudly manufactured in our Canadian production facility.

Devotion to Flexibility

The Intellicare series provides the ultimate in functionality with completely customizable options to suit any application. No space is ever too tight because all our products can be modified for size without additional cost or an increase in production lead time.

In the event you have a more unique need, Intellicare will design, draw, and create a completely made-to-order unit for any situation. If you can think of it, we can make it.

Impact on our Planet

Intellicare regularly reviews and updates our environmental policies and procedures to ensure a minimal impact on the world we live in. Taking care of your environment is our business, but taking care of the planet is our responsibility. Our dedication to living and working green is demonstrated in our product receiving SCS Indoor Air Quality Gold certification. Additionally, we offer consumers seeking LEED credits for their facility the benefit of several LEED qualifications including low emissions and recycled content.

Unequaled Reliability

When you believe in your product, it's easy to stand behind. Intellicare is becoming the most trusted name by offering a limited lifetime warranty. Intellicare warrants its products to be free from defects in material and workmanship for the life of the product through normal use. Please see our warranty information for full info.

Made in Canada

All products are manufactured on a per order basis, locally in Mississauga, Ontario. Our commitment to quality extends throughout the company's growing staff, cultivating a company culture of excellence we're proud of.

SCS Indoor Air Quality Gold Certification

Voluntarily testing that determines individual volatile organic compounds (VOC) emissions in a product. In addition to testing, audits of quality management procedures and the facility site are required to attain Gold certification.



Table of Contents

CASEGOODS	Pg. 4-37
100 Series	Pg. 4-8
200 Series	Pg. 9-13
400 Series	Pg. 14-18
500 Series	Pg. 19-23
Headboards & Footboards	Pg. 24
Handles	Pg. 25
Metal Legs	Pg. 26
Fronts, Tops & Kickplates	Pg. 27
Laminates	Pg. 28-29
Solid Surfaces	Pg. 30-37
DINING TABLES	Pg. 38-42
Wood Finishes	Pg. 43-44
HOW TO ORDER	Pg. 45
SEATING	Pg. 46-103
Wood Frame Dining	Pg.46-48
Aluminum Frame Dining	Pg. 49-51
Lounge	Pg. 52-56
Patient Room Seating	Pg. 57
Office	Pg. 58-61
Metal Frame Guest Chairs	Pg. 62
FABRIC OFFERING	Pg. 63-121
WOOD & ALUMINUM SEATING FINISHES	Pg. 122-124
LIGHTING & TECHNOLOGY	Pg. 125-129
MATTRESSES & FOUNDATIONS	Pg. 130-133
SPECS	Pg. 133
TERMS	Pg. 134
WARRANTY	Pg. 135
ENVIRONMENTAL	Pg. 136

100 & 100+ Series Notes

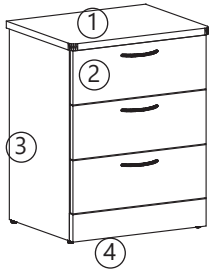

1. 1" TFL Top (1/2" Radius Overhang Sides/Front) Radius Corners
2. TFL Doors and Drawers Partially Outset on Gables
3. 1" TFL Side and Back Panels
4. TFL Kickplate

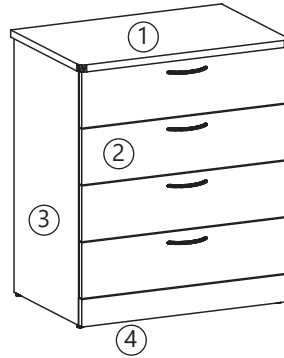

1. 1" TFL Top (1/2" Radius Overhang Sides/Front) Radius Corners
2. TFL Doors and Drawers Partially Outset on Gables
3. 1" TFL Side and Back Panels
4. TFL Kickplate

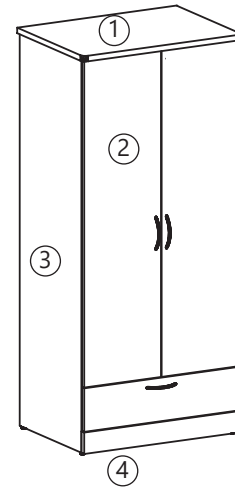

1. 1" TFL Top (1/2" Radius Overhang Sides/Front) Radius Corners
2. TFL Doors and Drawers Partially Outset on Gables
3. 1" TFL Side and Back Panels
4. TFL Kickplate
(Coatrod & Shelf Included)

100 Series and 100 + Series Standard Construction.

- Solid Back
- 3/4" Drawer and Door Fronts
- Full Suspension 125 lb slides with Safety Stopper Extension, Ball Bearing Slides with Accident Prevention Safety Clip
- 175 Degree Door Hinges
- To Add a Thermofoil Top = H1+. For Thermofoil Top & Faces See 400 Series
- For Metal Legs See Leg Options for Pricing

100 Series Upgrades & Accessories

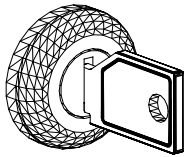

Add a Lock (please specify keyed alike if required)

LCK \$45 Each

Example: H1/BT/2020/DW/DO/L/29/LCK

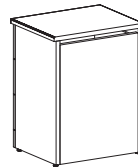

Add a Vent

VNT No Upcharge

Example: H1/BT/2020/DW/DO/L/29/VNT



Add a Drawer Liner for a Bedside Table

BTDL \$65 Per Drawer

Example: H1/BT/2020/DW/DO/L/29/BTDL

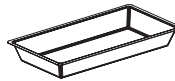

Add a Drawer Liner for a Dresser

DWDL \$80 Per Drawer

Example: H1/BT/2020/DW/DO/L/29/DRDL

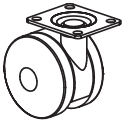

Add Casters

/2CAST (2 Casters / 2 Glides) \$55 Per Set

Example: H1/BT/2020/DW/DO/L/29/2CAST



Add Medical Grade Casters

/2MEDCAST (2 Casters / 2 Glides) \$157 Per Set

Example: H1/BT/2020/DW/DO/L/29/2MEDCAST

100 Series

100 + Series

1" TFL. Radius Top with 1/2" Overhang

1" Thermoform Top with Radius 1/2" Overhang

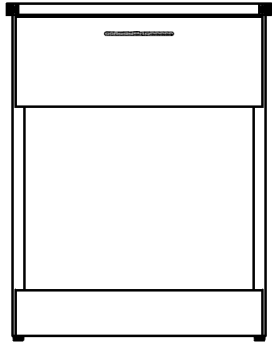

Single Drawer Bedside Table

Series	Size (W x D x H)	Code	List Price
100	20" x 20" x 29"	H1/BT/2020/DW/OP/29	\$448
100 +	20" x 20" x 29"	H1+/BT/2020/DW/OP/29	\$564

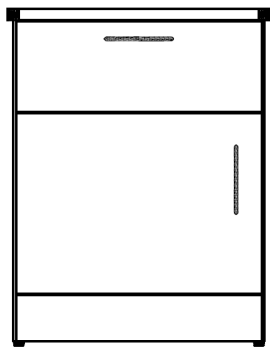

Single Drawer & Left Door Bedside Table

Series	Size (W x D x H)	Code	List Price
100	20" x 20" x 29"	H1/BT/2020/DW/DO/L/29	\$479
100 +	20" x 20" x 29"	H1+/BT/2020/DW/DO/L/29	\$601

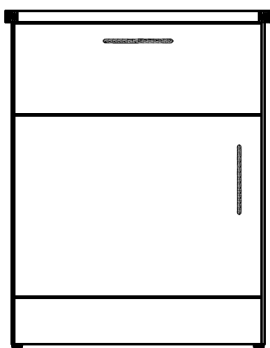

Single Drawer & Right Door Bedside Table

Series	Size (W x D x H)	Code	List Price
100	20" x 20" x 29"	H1/BT/2020/DW/DO/R/29	\$479
100 +	20" x 20" x 29"	H1+/BT/2020/DW/DO/R/29	\$601

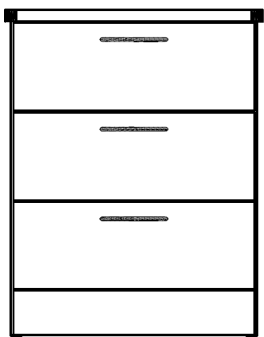

3 Drawer Bedside Table

Series	Size (W x D x H)	Code	List Price
100	20" x 20" x 29"	H1/BT/2020/3DW/29	\$526
100 +	20" x 20" x 29"	H1+/BT/2020/3DW/29	\$642

100 Series

100 + Series

1" TFL. Radius Top with 1/2" Overhang

1" Thermoform Top with Radius 1/2" Overhang

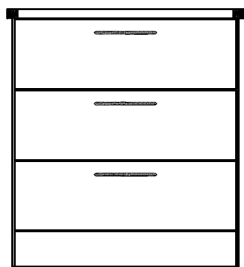

3 Drawer Dresser

Series	Size (W x D x H)	Code	List Price
100	33" x 20" x 29"	H1/DR/3320/3DW/29	\$664
100 +	33" x 20" x 29"	H1+/DR/3320/3DW/29	\$883

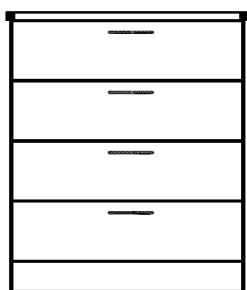

4 Drawer Dresser

Series	Size (W x D x H)	Code	List Price
100	33" x 20" x 36"	H1/DR/3320/4DW/36	\$805
100 +	33" x 20" x 36"	H1+/DR/3320/4DW/36	\$1024

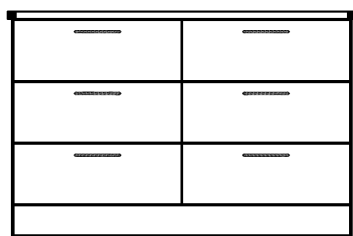

6 Drawer Dresser

Series	Size (W x D x H)	Code	List Price
100	61" x 20" x 29"	H1/DR/6120/6DW/29	\$1165
100 +	61" x 20" x 29"	H1+/DR/6120/6DW/29	\$1565

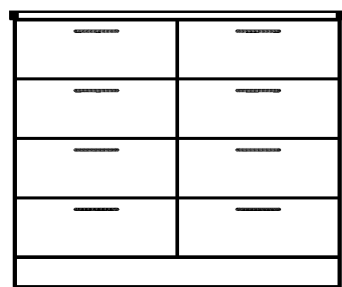

8 Drawer Dresser

Series	Size (W x D x H)	Code	List Price
100	61" x 20" x 36"	H1/DR/6120/8DW/36	\$1299
100 +	61" x 20" x 36"	H1+/DR/6120/8DW/36	\$1722

Right

Left

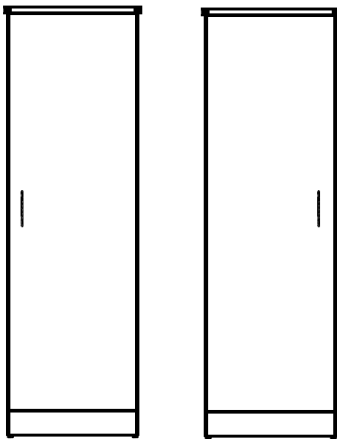

Single Door Wardrobe

Series	L/R	Size (W x D x H)	Code	List Price
100	R	22" x 24" x 72"	H1/WR/2224/1DO/R/72	\$861
100	L	22" x 24" x 72"	H1/WR/2224/1DO/L/72	\$861
100	R	22" x 24" x 78"	H1/WR/2224/1DO/R/78	\$1034
100	L	22" x 24" x 78"	H1/WR/2224/1DO/L/78	\$1034

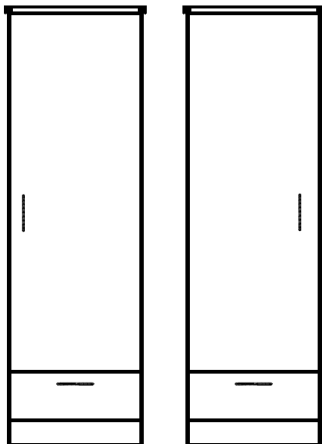

Single Door & Single Drawer Wardrobe

Series	L/R	Size (W x D x H)	Code	List Price
100	R	22" x 24" x 72"	H1/WR/2224/1DO/1DW/R/72	\$939
100	L	22" x 24" x 72"	H1/WR/2224/1DO/1DW/L/72	\$939
100	R	22" x 24" x 78"	H1/WR/2224/1DO/1DW/R/78	\$1127
100	L	22" x 24" x 78"	H1/WR/2224/1DO/1DW/L/78	\$1127

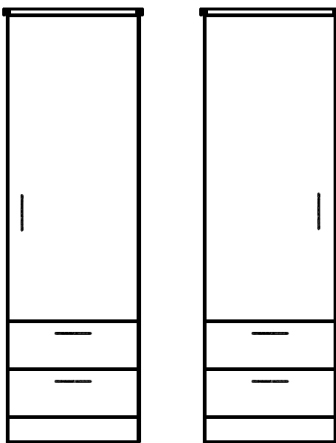

Single Door & Double Drawer Wardrobe

Series	L/R	Size (W x D x H)	Code	List Price
100	R	22" x 24" x 72"	H1/WR/2224/1DO/2DW/R/72	\$1002
100	L	22" x 24" x 72"	H1/WR/2224/1DO/2DW/L/72	\$1002
100	R	22" x 24" x 78"	H1/WR/2224/1DO/2DW/R/78	\$1203
100	L	22" x 24" x 78"	H1/WR/2224/1DO/2DW/L/78	\$1203

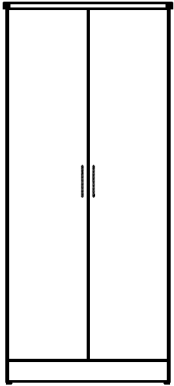

Double Door Wardrobe

Series	Size (W x D x H)	Code	List Price
100	36" x 24" x 72"	H1/WR/3624/2DO/72	\$1159
100	36" x 24" x 78"	H1/WR/3624/2DO/78	\$1391

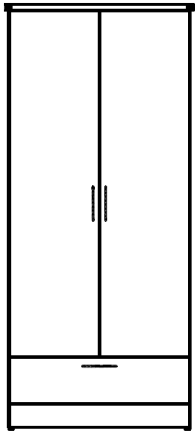

Double Door & Single Drawer Wardrobe

Series	Size (W x D x H)	Code	List Price
100	36" x 24" x 72"	H1/WR/3624/2DO/1DW/72	\$1227
100	36" x 24" x 78"	H1/WR/3624/2DO/1DW/78	\$1473

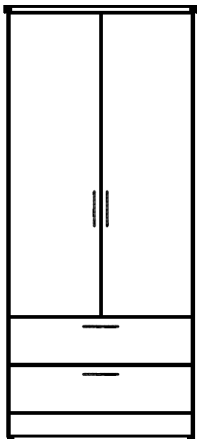

Double Door & Double Drawer Wardrobe

Series	Size (W x D x H)	Code	List Price
100	36" x 24" x 72"	H1/WR/3624/2DO/2DW/72	\$1315
100	36" x 24" x 78"	H1/WR/3624/2DO/2DW/78	\$1578

200 & 200+ Series Notes

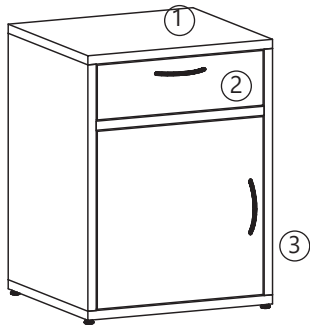

1. TFL 1" Flush Top
2. Door and Drawers Inset to Gables
3. 1" TFL Side Panels

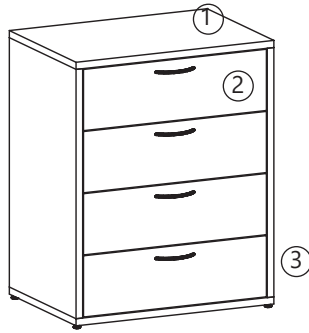

1. TFL 1" Flush Top
2. Door and Drawers Inset to Gables
3. 1" TFL Side Panels

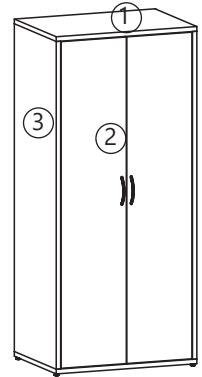

1. TFL 1" Flush Top
2. Door and Drawers Inset to Gables
3. 1" TFL Side Panels
(Coat Rod & Shelf Included)

200 Series and 200 + Series Standard Construction.

- Solid Back
- 3/4" Drawer and Door Fronts
- Full Suspension 125 lb slides with Safety Stopper Extension, Ball Bearing Slides with Accident Prevention Safety Clip
- 1.5" Top & Sides Available as 300 Series
- For Metal Legs See Leg Options for Pricing

200 Series Upgrades & Accessories

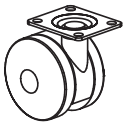

Add Casters
 /4CAST (4 casters /
 2 locking) \$110 Per Unit
 Example: H2/BT/2020/DW/DO/L/29/4CAST

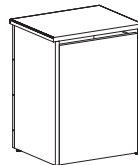

Add a Vent
 VNT No Upcharge
 Example: H2/BT/2020/DW/DO/L/29/VNT

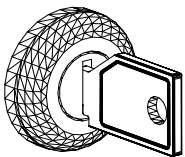

Add a Lock (please specify keyed alike if required)
 LCK \$45 Each
 Example: H2/BT/2020/DW/DO/L/29/LCK



Add a Drawer Liner for a Dresser
 DWDL \$80 Per Drawer
 Example: H2/BT/2020/DW/DO/L/29/DRDL



Add a Drawer Liner for a Bedside Table
 BTDL \$65 Per Drawer
 Example: H2/BT/2020/DW/DO/L/29/BTDL



Add Medical Grade Casters
 /4MEDCAST (4 Casters / 2 Locking) \$313 Per Set
 Example: H2/BT/2020/DW/DO/L/29/4MEDCAST

200 Series

200 + Series

1" TFL with Inside Drawers and Doors. Flush Tops.

1" Thermoform Top with Radius 1/2" Overhang

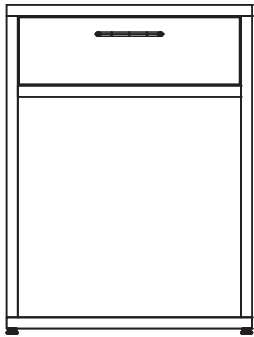

Single Drawer Bedside Table

Series	Size (W x D x H)	Code	Price
200	19" x 19.5" x 29"	H2/BT/1919.5/DW/OP/29	\$448
200 +	20" x 20" x 29"	H2+/BT/2020/DW/OP/29	\$564

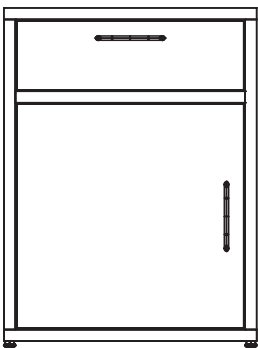

Single Drawer & Left Door Bedside Table

Series	Size (W x D x H)	Code	Price
200	19" x 19.5" x 29"	H2/BT/1919.5/DW/DO/L/29	\$479
200 +	20" x 20" x 29"	H2+/BT/2020/DW/DO/L/29	\$601

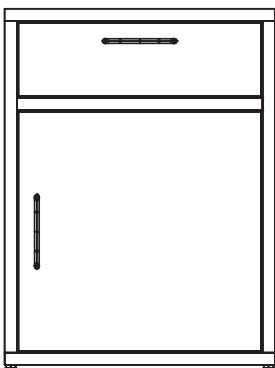

Single Drawer & Right Door Bedside Table

Series	Size (W x D x H)	Code	Price
200	19" x 19.5" x 29"	H2/BT/1919.5/DW/DO/R/29	\$479
200 +	20" x 20" x 29"	H2+/BT/2020/DW/DO/R/29	\$601

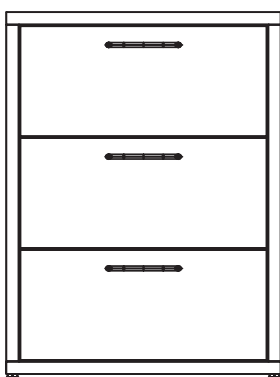

3 Drawer Bedside Table

Series	Size (W x D x H)	Code	Price
200	19" x 19.5" x 29"	H2/BT/1919.5/3DW/29	\$542
200 +	20" x 20" x 29"	H2+/BT/2020/3DW/29	\$642

200 Series

200 + Series

1" TFL with Inside Drawers and Doors. Flush Tops.

1" Thermoform Top with Radius 1/2" Overhang

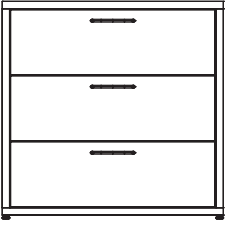

3 Drawer Dresser

Series	Size (W x D x H)	Code	Price
200	32" x 19.5" x 29"	H2/DR/3219.5/3DW/29	\$664
200 +	33" x 20" x 29"	H2+/DR/3320/3DW/29	\$883

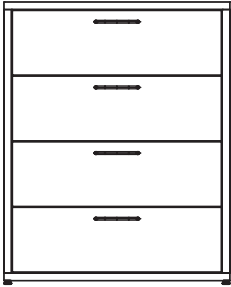

4 Drawer Dresser

Series	Size (W x D x H)	Code	Price
200	32" x 19.5" x 36"	H2/DR/3219.5/4DW/36	\$815
200 +	33" x 20" x 36"	H2+/DR/3320/4DW/36	\$1024

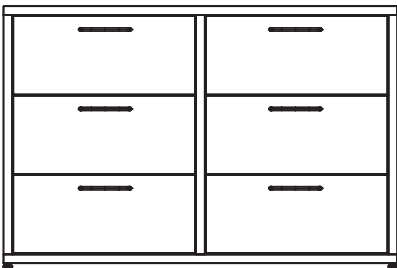

6 Drawer Dresser

Series	Size (W x D x H)	Code	Price
200	60" x 19.5" x 29"	H2/DR/6019.5/6DW/29	\$1165
200 +	61" x 20" x 29"	H2+/DR/6120/6DW/29	\$1565

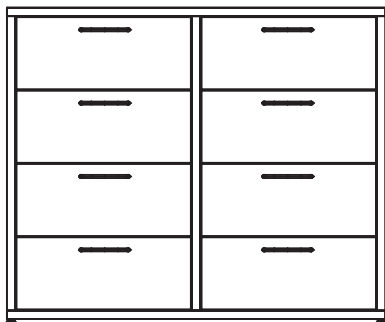

8 Drawer Dresser

Series	Size (W x D x H)	Code	Price
200	60" x 19.5" x 36"	H2/DR/6019.5/8DW/36	\$1310
200 +	61" x 20" x 36"	H2+/DR/6120/8DW/36	\$1722

Right

Left

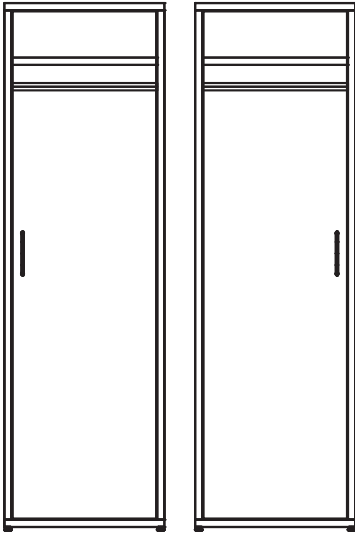

Single Door Wardrobe

Series	L/R	Size (W x D x H)	Code	Price
200	R	21" x 23.5" x 72"	H2/WR/2123.5/1DO/R/72	\$861
200	L	21" x 23.5" x 72"	H2/WR/2123.5/1DO/L/72	\$861
200	R	21" x 23.5" x 78"	H2/WR/2123.5/1DO/R/78	\$1034
200	L	21" x 23.5" x 78"	H2/WR/2123.5/1DO/L/78	\$1034

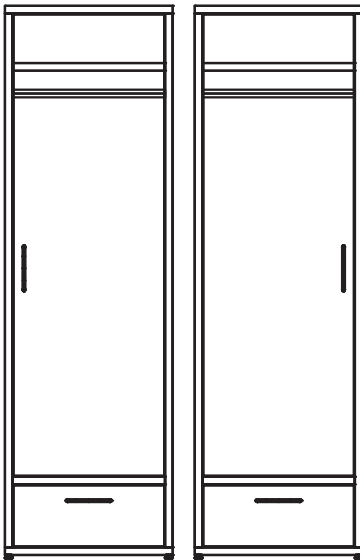

Single Door & Single Drawer Wardrobe

Series	L/R	Size (W x D x H)	Code	Price
200	R	21" x 23.5" x 72"	H2/WR/2123.5/1DO/1DW/R/72	\$939
200	L	21" x 23.5" x 72"	H2/WR/2123.5/1DO/1DW/L/72	\$939
200	R	21" x 23.5" x 78"	H2/WR/2123.5/1DO/1DW/R/78	\$1127
200	L	21" x 23.5" x 78"	H2/WR/2123.5/1DO/1DW/L/78	\$1127

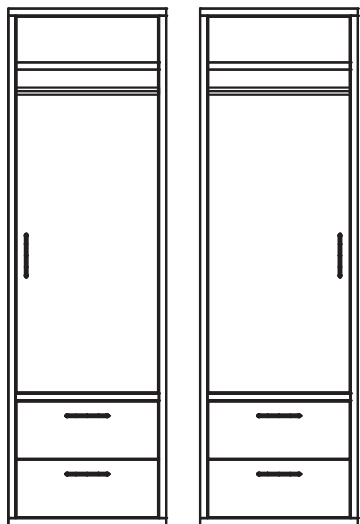

Single Door & Double Drawer Wardrobe

Series	L/R	Size (W x D x H)	Code	Price
200	R	21" x 23.5" x 72"	H2/WR/2123.5/1DO/2DW/R/72	\$1002
200	L	21" x 23.5" x 72"	H2/WR/2123.5/1DO/2DW/L/72	\$1002
200	R	21" x 23.5" x 78"	H2/WR/2123.5/1DO/2DW/R/78	\$1203
200	L	21" x 23.5" x 78"	H2/WR/2123.5/1DO/2DW/L/78	\$1203

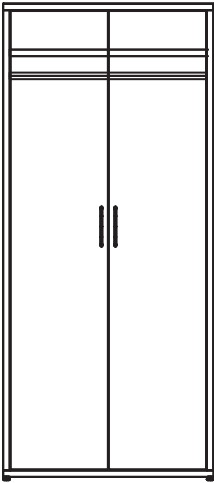

Double Door Wardrobe

Series	Size (W x D x H)	Code	Price
200	35" x 23.5" x 72"	H2/WR/3523.5/2DO/72	\$1159
200	35" x 23.5" x 78"	H2/WR/3523.5/2DO/78	\$1391

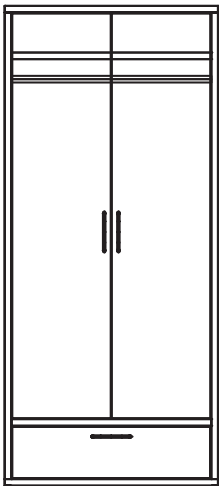

Double Door & Single Drawer Wardrobe

Series	Size (W x D x H)	Code	Price
200	35" x 23.5" x 72"	H2/WR/3523.5/2DO/1DW/72	\$1227
200	35" x 23.5" x 78"	H2/WR/3523.5/2DO/1DW/78	\$1473

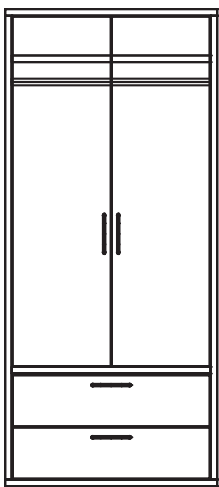

Double Door & Double Drawer Wardrobe

Series	Size (W x D x H)	Code	Price
200	35" x 23.5" x 72"	H2/WR/3523.5/2DO/2DW/72	\$1315
200	35" x 23.5" x 78"	H2/WR/3523.5/2DO/2DW/78	\$1578

400 Series Notes



1. Thermoform 1" Top (1/2" Radius Overhang)
2. Thermoform Doors and Drawers Set Outside
3. 1" TFL Side Panels
4. Thermoform Kickplate



1. Thermoform 1" Top (1/2" Radius Overhang)
2. Thermoform Doors and Drawers Set Outside
3. 1" TFL Side Panels
4. Thermoform Kickplate

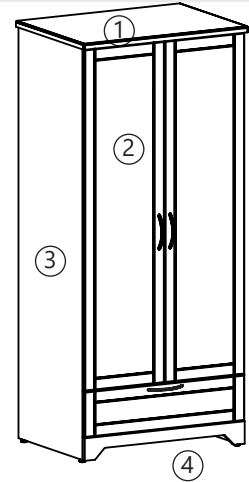

1. TFL 1" Top (1/2" Square Overhang)
2. Thermoform Doors and Drawers Set Outside
3. 1" TFL Side Panels
4. Thermoform Kickplate
(Coatrod & Shelf Included)

400 Series Standard Construction.

- Solid Back
- 3/4" Drawer and Door Fronts
- Full Suspension 125 lb slides with Safety Stopper Extension, Ball Bearing Slides with Accident Prevention Safety Clip
- 175 Degree Door Hinges
- For Metal Legs See Leg Options for Pricing

400 Series Upgrades & Accessories

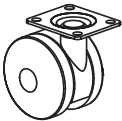

Add Casters
 /2CAST (2 casters / 2 glides) \$55 Per Unit
 Example: H4/BT/2020/DW/DO/L/29/2CAST



Add Medical Grade Casters
 /2MEDCAST (2 Casters / 2 Glides) \$157 Per Set
 Example: H1/BT/2020/DW/DO/L/29/2MEDCAST

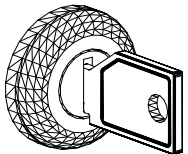

Add a Lock (please specify keyed alike if required)
 LCK \$45 Each
 Example: H4/BT/2020/DW/DO/L/29/LCK

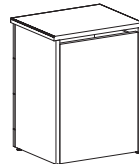

Add a Vent
 VNT No Upcharge
 Example: H4/BT/2020/DW/DO/L/29/VNT



Add a Drawer Liner for a Bedside Table
 BTDL \$60 Per Drawer
 Example: H4/BT/2020/DW/DO/L/29/BTDL

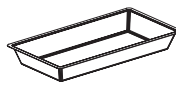

Add a Drawer Liner for a Dresser
 DRDL \$80 Per Drawer
 Example: H4/BT/2020/DW/DO/L/29/DRDL

400 Series

1" Thermoform Top with Radius 1/2" Overhang.
3/4" Thermoform Fronts.

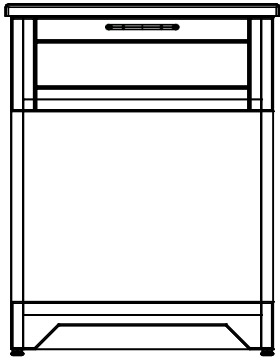

Single Drawer Bedside Table

Series	Size (W x D x H)	Code	Price
400	20" x 20" x 29"	H4/BT/2020/DW/OP/29	\$736

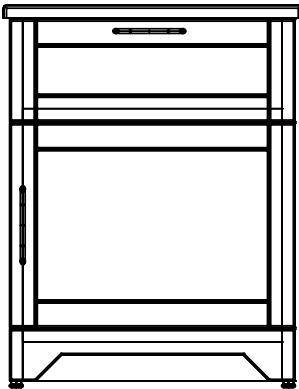

Single Drawer & Right Door Bedside Table

Series	Size (W x D x H)	Code	Price
400	20" x 20" x 29"	H4/BT/2020/DW/DO/R/29	\$752

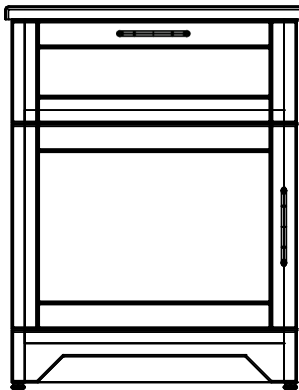

Single Drawer & Left Door Bedside Table

Series	Size (W x D x H)	Code	Price
400	20" x 20" x 29"	H4/BT/2020/DW/DO/L/29	\$752

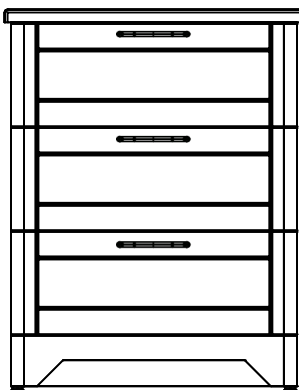

3 Drawer Bedside Table

Series	Size (W x D x H)	Code	Price
400	20" x 20" x 29"	H4/BT/2020/3DW/29	\$767

400 Series

1" Thermoform Top with Radius 1/2" Overhang.
3/4" Thermoform Fronts.



3 Drawer Dresser

Series	Size (W x D x H)	Code	Price
400	33" x 20" x 29"	H4/DR/3320/3DW/29	\$1112

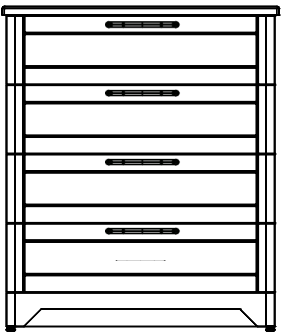

4 Drawer Dresser

Series	Size (W x D x H)	Code	Price
400	33" x 20" x 36"	H4/DR/3320/4DW/36	\$1206



6 Drawer Dresser

Series	Size (W x D x H)	Code	Price
400	61" x 20" x 29"	H4/DR/6120/6DW/29	\$1853



8 Drawer Dresser

Series	Size (W x D x H)	Code	Price
400	61" x 20" x 36"	H4/DR/6120/8DW/36	\$2035

400 Series

1" TFL Top with Square 1/2" Overhang.
3/4" Thermoform Fronts.

Right

Left

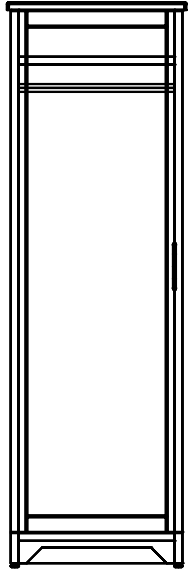
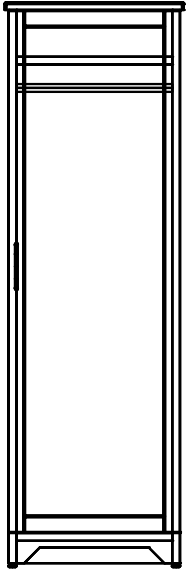

Single Door Wardrobe

L/R	Size (W x D x H)	Code	Price
R	22" x 24" x 72"	H4/WR/2224/1DO/R/72	\$1268
L	22" x 24" x 72"	H4/WR/2224/1DO/L/72	\$1268
R	22" x 24" x 78"	H4/WR/2224/1DO/R/78	\$1522
L	22" x 24" x 78"	H4/WR/2224/1DO/L/78	\$1522

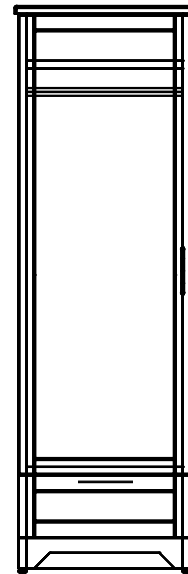
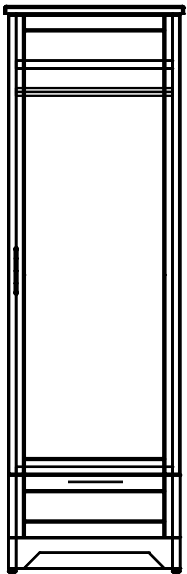

Single Door & Single Drawer Wardrobe

L/R	Size (W x D x H)	Code	Price
R	22" x 24" x 72"	H4/WR/2224/1DO/1DW/R/72	\$1384
L	22" x 24" x 72"	H4/WR/2224/1DO/1DW/L/72	\$1384
R	22" x 24" x 78"	H4/WR/2224/1DO/1DW/R/78	\$1661
L	22" x 24" x 78"	H4/WR/2224/1DO/1DW/L/78	\$1661

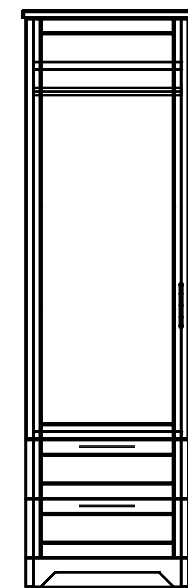
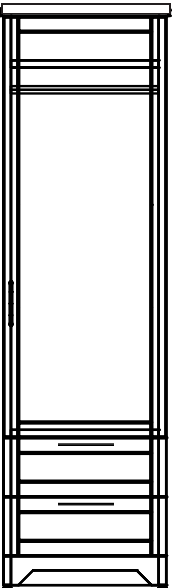

Single Door & Double Drawer Wardrobe

L/R	Size (W x D x H)	Code	Price
R	22" x 24" x 72"	H4/WR/2224/1DO/2DW/R/72	\$1456
L	22" x 24" x 72"	H4/WR/2224/1DO/2DW/L/72	\$1456
R	22" x 24" x 78"	H4/WR/2224/1DO/2DW/R/78	\$1747
L	22" x 24" x 78"	H4/WR/2224/1DO/2DW/L/78	\$1747

400 Series

1" TFL Top with Square 1/2" Overhang.
3/4" Thermoform Fronts.

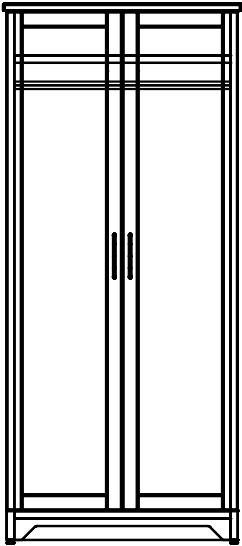

Double Door Wardrobe

Size (W x D x H)	Code	Price
36" x 24" x 72"	H4/WR/3624/2DO/72	\$1760
36" x 24" x 78"	H4/WR/3624/2DO/78	\$2121

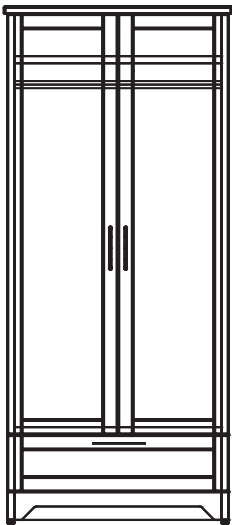

Double Door & Single Drawer Wardrobe

Size (W x D x H)	Code	Price
36" x 24" x 72"	H4/WR/3624/2DO/1DW/72	\$1841
36" x 24" x 78"	H4/WR/3624/2DO/1DW/78	\$2210

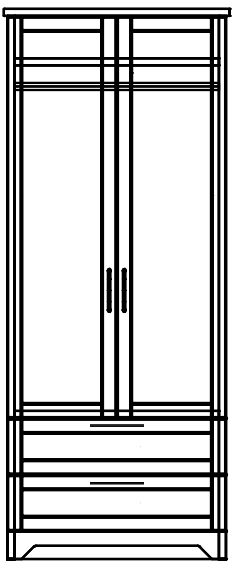

Double Door & Double Drawer Wardrobe

Size (W x D x H)	Code	Price
36" x 24" x 72"	H4/WR/3624/2DO/2DW/72	\$1878
36" x 24" x 78"	H4/WR/3624/2DO/2DW/78	\$2254

500 & 500+ Series Notes

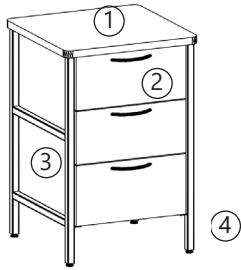

1. 1" TFL Top (1/2" Radius Overhang Sides/Front)
2. TFL Doors and Drawers Set Outside
3. 1" TFL Side Panels
4. 1" Heavy Gauge Steel Legs

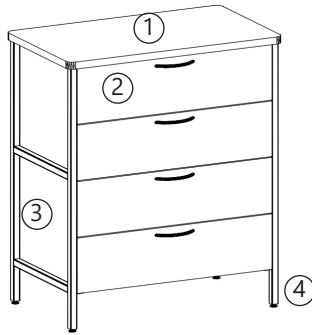

1. 1" TFL Top (1/2" Radius Overhang)
2. TFL Doors and Drawers Set Outside
3. 1" TFL Side Panels
4. 1" Heavy Gauge Steel Legs

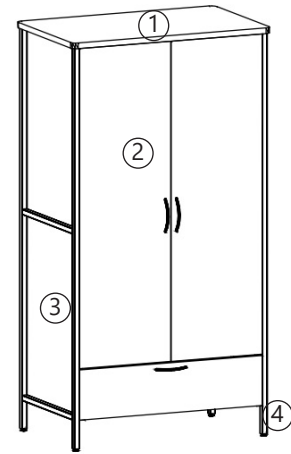

1. 1" TFL Top (1/2" Overhang)
2. TFL Doors and Drawers Set Outside
3. 1" TFL Side Panels
4. 1" Heavy Gauge Steel Legs

500 Series Standard Construction.

- Solid Back
- 3/4" Drawer and Door Fronts
- Full Suspension 125 lb slides with Safety Stopper Extension, Ball Bearing Slides with Accident Prevention Safety Clip
- Heavy Gauge Steel Legs with Centre Crossbar for Rigidity
- 175 Degree Door Hinges

500 Series Upgrades & Accessories

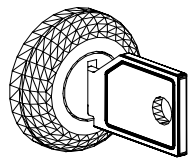

Add a Lock (please specify keyed alike if required)

LCK \$45 Each

Example: H5/BT/2020/DW/DO/L/30/LCK

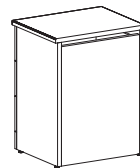

Add a Vent

VNT No Upcharge

Example: H5/BT/2020/DW/DO/L/30/VNT



Add a Drawer Liner for a Bedside Table

BTDL \$65 Per Drawer

Example: H5/BT/2020/DW/DO/L/30/BTDL



Add a Drawer Liner for a Dresser

DWDL \$80 Per Drawer

Example: H5/BT/2020/DW/DO/L/30/DRDL



Add Medical Casters

/4MEDCAST (4 Casters) \$313 Per Set

Example: H5/BT/2020/DW/DO/L/30/4MEDCAST

500 Series

500+ Series

1" TFL. Radius Top with Radius 1/2" Overhang
 1" Thermoform Top with Radius 1/2" Overhang

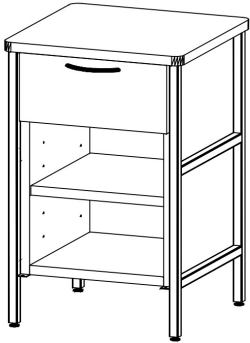

Single Drawer Bedside Table

Series	Size (W x D x H)	Code	List Price
500	23" x 20.5" x 30"	H5/BT/2320.5/DW/OP/30	\$1043
500+	23" x 20.4" x 30"	H5+/BT/2320.5/DW/OP/30	\$1133

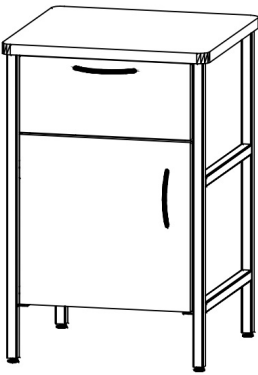

Single Drawer & Left Door Bedside Table

Series	Size (W x D x H)	Code	List Price
500	23" x 20.5" x 30"	H5/BT/2320.5/DW/DO/L/30	\$1074
500+	23" x 20.5" x 30"	H5+/BT/2320.5/DW/DO/L/30	\$1164

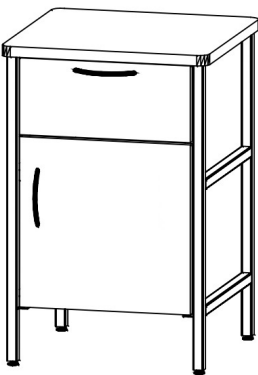

Single Drawer & Right Door Bedside Table

Series	Size (W x D x H)	Code	List Price
500	23" x 20.5" x 30"	H5/BT/2320.5/DW/DO/R/30	\$1074
500+	23" x 20.5" x 30"	H5+/BT/2320.5/DW/DO/R/30	\$1164

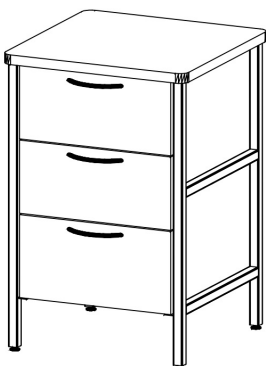

3 Drawer Bedside Table

Series	Size (W x D x H)	Code	List Price
500	23" x 20.5" x 30"	H5/BT/2320.5/3DW/30	\$1121
500+	23" x 20.5" x 30"	H5+/BT/2320.5/3DW/30	\$1211

500 Series

500+ Series

1" TFL. Radius Top with Radius 1/2" Overhang
 1" Thermoform Top with Radius 1/2" Overhang



3 Drawer Dresser

Series	Size (W x D x H)	Code	List Price
500	36" x 20.5" x 30"	H5/DR/3620.5/3DW/30	\$1259
500+	36" x 20.5" x 30"	H5+/DR/3620.5/3DW/30	\$1394



4 Drawer Dresser

Series	Size (W x D x H)	Code	List Price
500	36" x 20.5" x 36"	H5/DR/3620.5/4DW/38	\$1490
500+	36" x 20.5" x 36"	H5+/DR/3620/4DW/38	\$1625



6 Drawer Dresser

Series	Size (W x D x H)	Code	List Price
500	63" x 20.5" x 30"	H5/DR/6320.5/6DW/30	\$1760
500+	63" x 20.5" x 30"	H5+/DR/6320.5/6DW/30	\$2039



8 Drawer Dresser

Series	Size (W x D x H)	Code	List Price
500	63" x 20.5" x 38"	H5/DR/6320.5/8DW/38	\$1984
500+	63" x 20.5" x 30"	H5+/DR/6320.5/8DW/38	\$2263

500 Series

1" TFL. Square Top with Radius 1/2" Overhang

Right

Left

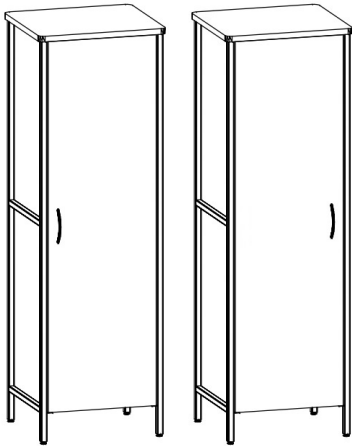

Single Door Wardrobe

Series	L/R	Size (W x D x H)	Code	List Price
500	R	25" x 24" x 72"	H5/WR/2524/1DO/R/72	\$1546
500	L	25" x 24" x 72"	H5/WR/2524/1DO/L/72	\$1546

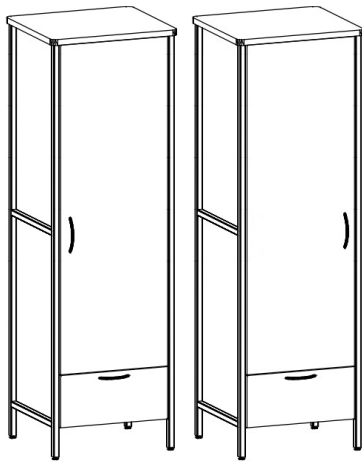

Single Door & Single Drawer Wardrobe

Series	L/R	Size (W x D x H)	Code	List Price
500	R	25" x 24" x 72"	H5/WR/2524/1DO/1DW/R/72	\$1624
500	L	25" x 24" x 72"	H5/WR/2524/1DO/1DW/L/72	\$1624



Single Door & Double Drawer Wardrobe

Series	L/R	Size (W x D x H)	Code	List Price
500	R	25" x 24" x 72"	H5/WR/2524/1DO/2DW/R/72	\$1687
500	L	25" x 24" x 72"	H5/WR/2524/1DO/2DW/L/72	\$1687

500 Series 500+ Series

1" TFL. Square Top with Radius 1/2" Overhang

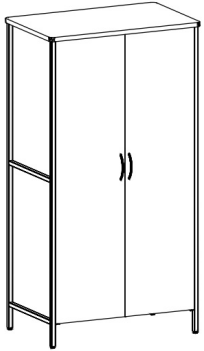

Double Door Wardrobe

Series	Size (W x D x H)	Code	List Price
500	39" x 24" x 72"	H5/WR/3924/2DO/72	\$1844

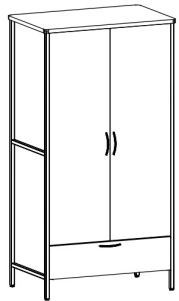

Double Door & Single Drawer Wardrobe

Series	Size (W x D x H)	Code	List Price
500	39" x 24" x 72"	H5/WR/3924/2DO/1DW/72	\$1912

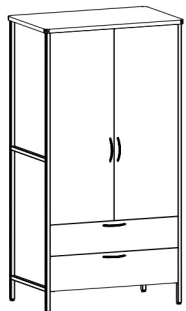

Double Door & Double Drawer Wardrobe

Series	Size (W x D x H)	Code	List Price
500	39" x 24" x 72"	H1/WR/3924/2DO/2DW/72	\$2000

Headboard & Footboards

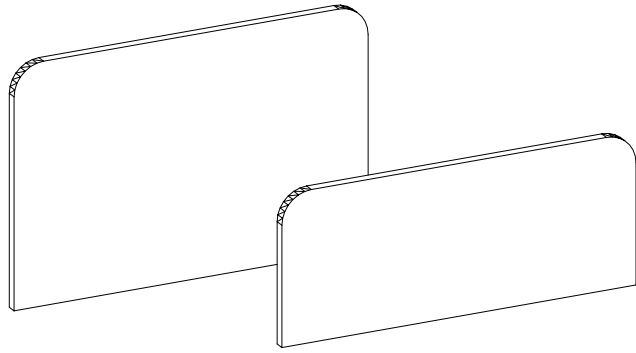

Radius

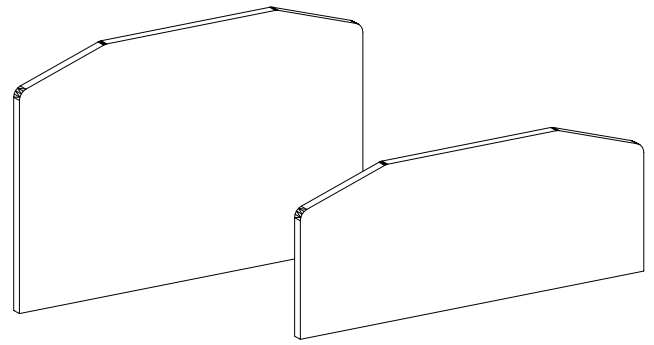

Angled

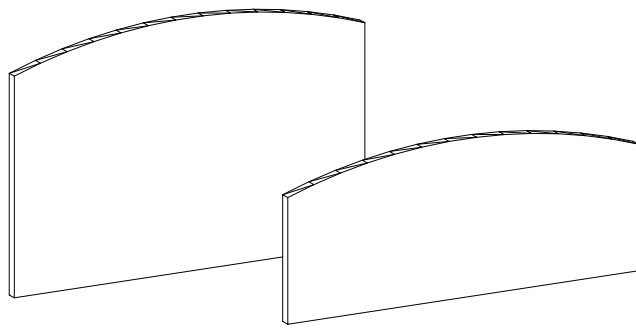

Bow

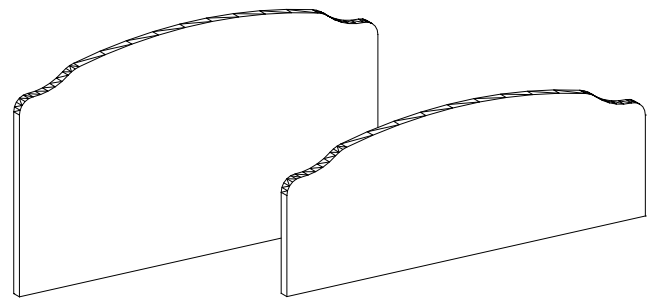

Curve

Headboard

Series	Size (W x H)	Code	Price
100	36" x 29" x 1"	H1/HEAD3629	\$130
400	36" x 29" x 3/4"	H4/HEAD3629	\$215

Footboard

Series	Size (W x H)	Code	Price
100	36" x 15" x 1"	H1/FOOT3615	\$115
400	36" x 15" x 3/4"	H4/FOOT3615	\$170

100 series headboard & footboard:

400 series headboard & footboard:

Choose your shape from above
(Radius, Angled, Bow, Curve)

Choose your shape and front style
(Radius, Angled, Bow, Curve)
(A,B,C,D,E,F)

Handle Option



Bar Nickel



Baton Nickel



Bridge Nickel



Cube Nickel

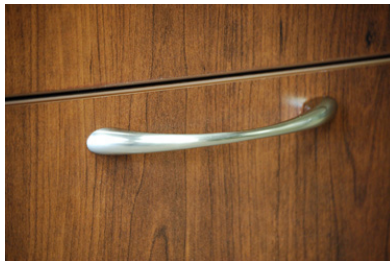

Flair Nickel



Flat Loop Brass

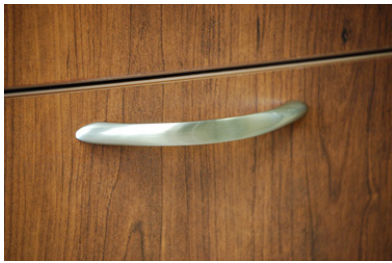

Flat Loop Nickel



Knob Brass



Knob Nickel



Rail Black



Rail Silver



Straight Black



Straight Silver



Waterfall Black



Waterfall Nickel

Intellicare Metal Leg Options

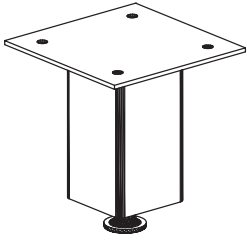

Metal Square Leg

Height	Code	List Price Per 4
4"	/4SQR	\$110

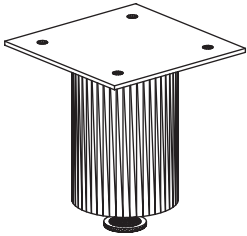

Metal Square Leg

Height	Code	List Price Per 4
4"	/4RND	\$110



Leg 1

Height	Code	List Price Per 4
4 3/4"	/4LEG1	\$448

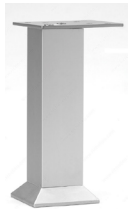

Leg 2

Height	Code	List Price Per 4
5 9/16"	/4LEG2	\$256



Leg 3

Height	Code	List Price Per 4
4 23/32"	/4LEG3	\$168

Thermofoil Front Styles

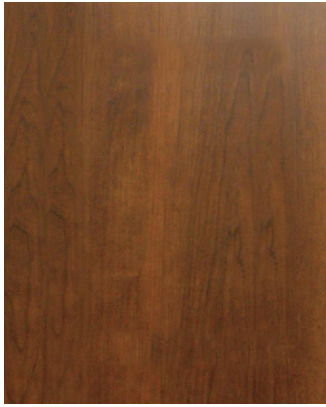

Front Style A

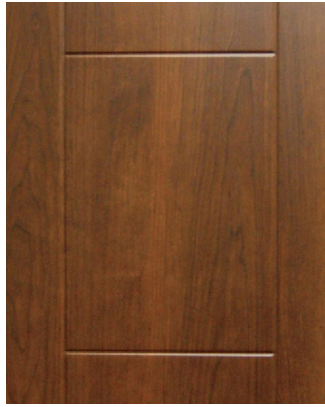

Front Style B



Front Style C



Front Style D

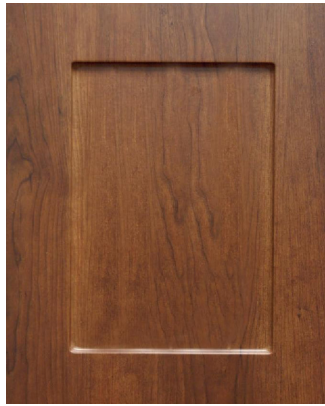

Front Style E

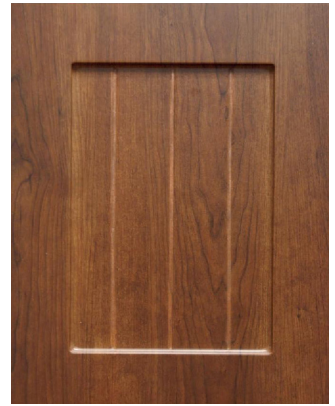

Front Style F

Thermofoil Top Profile Styles



Kickplate Styles



Square Kickplate



Angled Kickplate



Radius Kickplate

Laminate Finishes

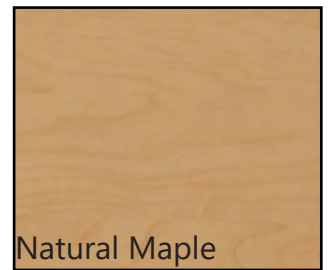
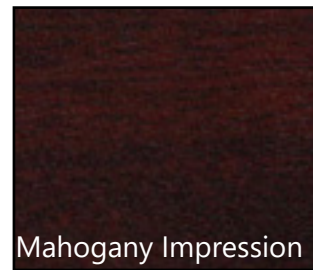
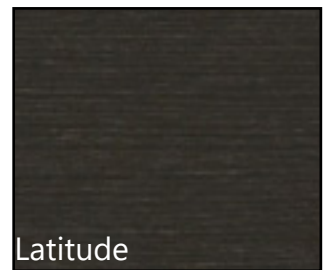
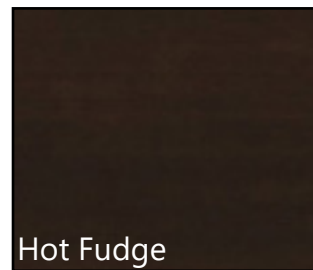
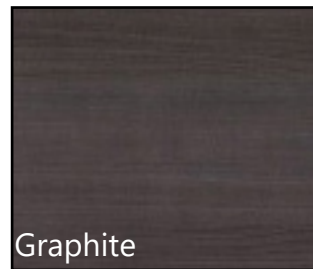
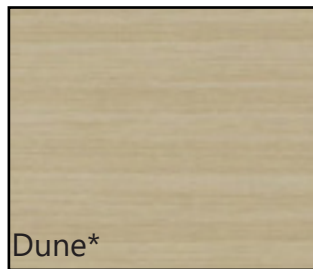
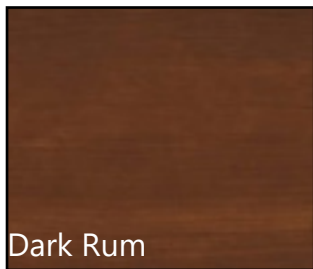
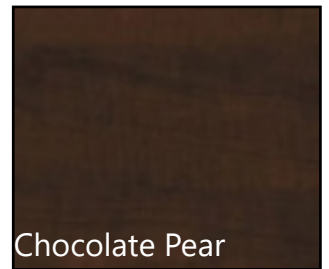
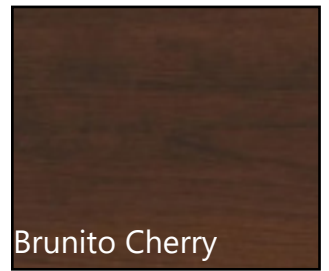
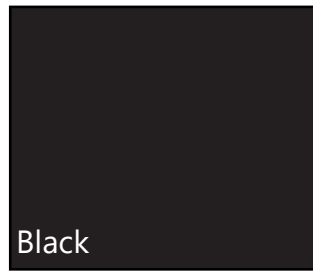

***Only Available in TFL**

Laminate Finishes

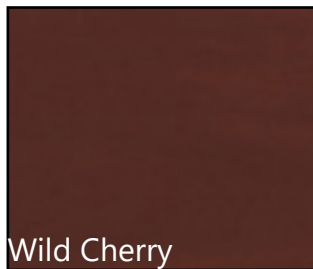
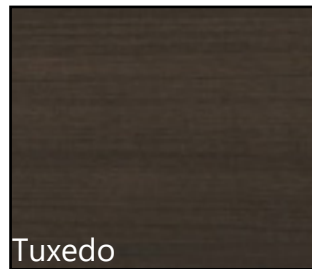
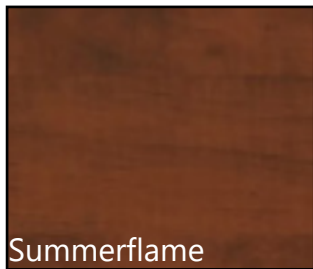
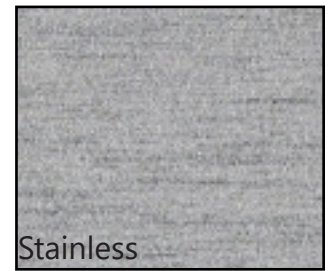
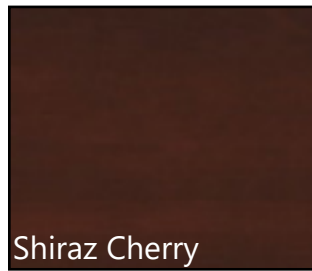
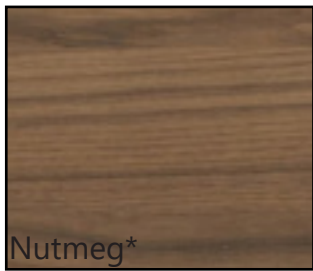

The Following Finishes **Do Not** Have a Thermofoil Match

- Dune
- Grey Likatree
- Grigio
- Laurentian
- Nutmeg

***Only Available in TFL**

Intellicare Solid Surface Options

Solid Surfaces are an available option on the surface of any Intellicare product. Due to the custom nature of solid surfaces, to add a solid surface top, please contact customer service to receive a custom drawing and quote.

Why Use a Solid Surface?

Solid surface is a man-made material that is non-porous, homogeneous and low-maintenance. The product can mimic the appearance of stone, wood and other naturally occurring materials. In contrast with other products, such as granite, the seams in solid surfaces are invisible. It is also completely bacteria and stain-resistant.

Solid surfaces have wide appeal because it is durable, impact resistant and waterproof. It's available in a huge range of colors and visual textures. The material is also renewable; its solid nature means that it can be refinished or repaired when scratched or damaged.

Please contact your Intellicare sales representative for more details.

Available Solid Surfaces:

Corian

Hanex

Staron Samsung

Wilsonart

Hanex Solid Surfaces Solo

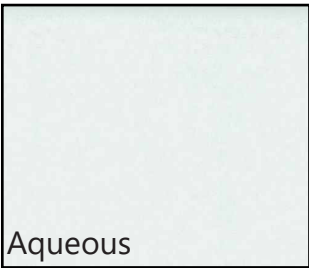

Hanex Solid Surfaces Duo

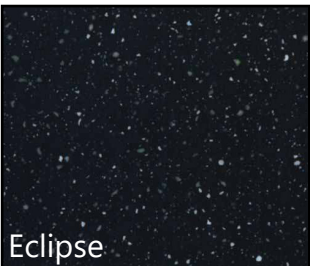
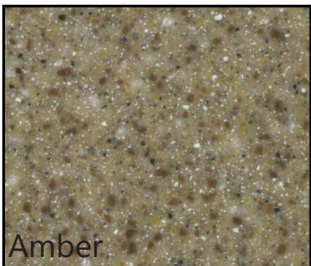
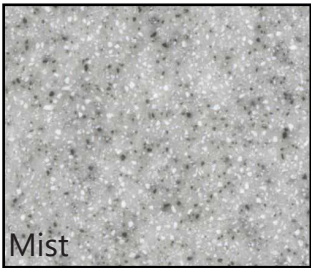
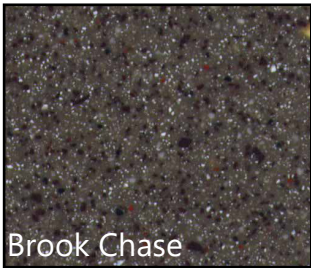
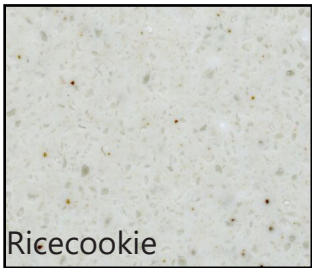
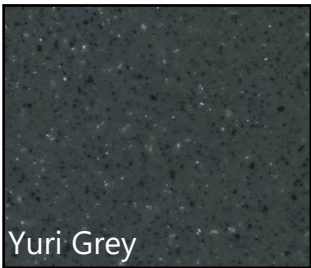
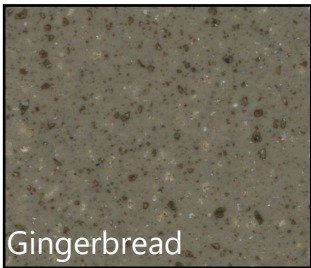

DuPont Corian Finishes

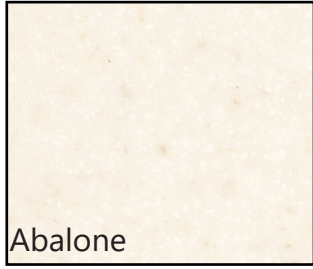

Abalone

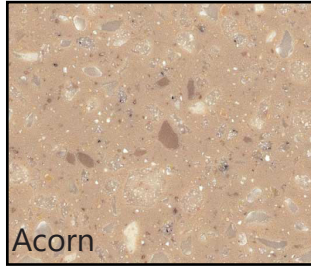

Acorn

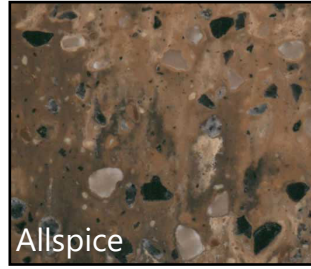

Allspice



Antarctica



Anthracite



Aqualite

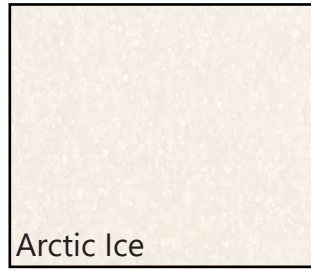

Arctic Ice

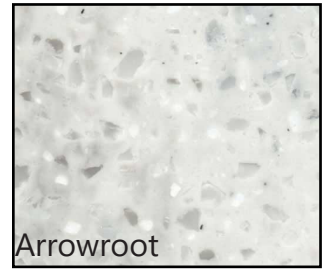

Arrowroot



Ash Concrete



Aurora

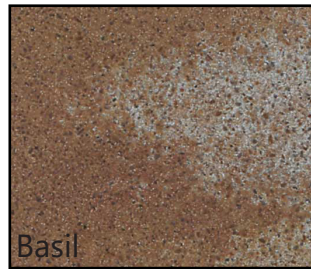

Basil

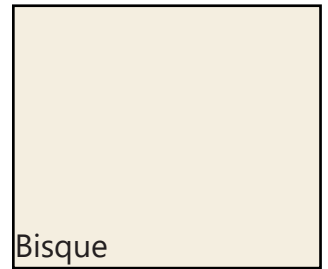

Bisque

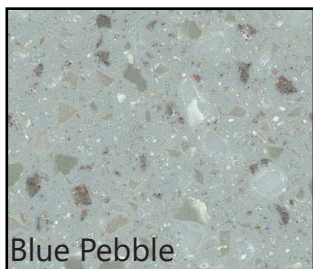

Blue Pebble



Blue Spice

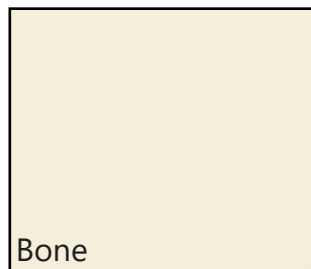

Bone



Windswept Prima



Burled Beach

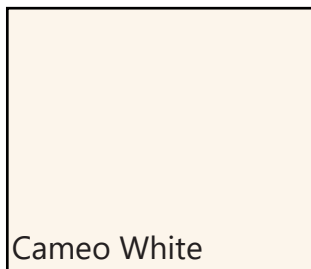

Cameo White



Canvas



Canyon



Carbon Concrete

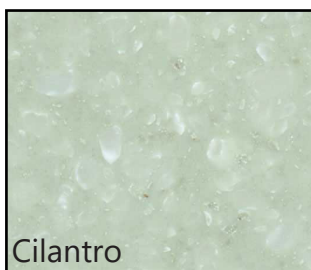

Cilantro

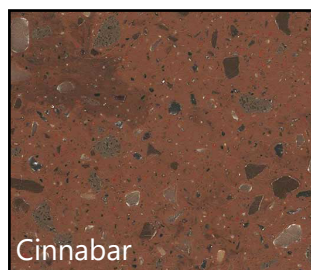

Cinnabar



Clam Shell

DuPont Corian Finishes

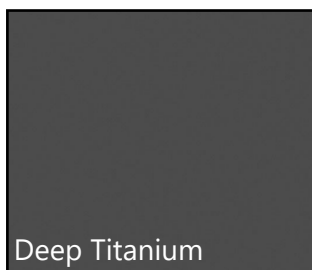
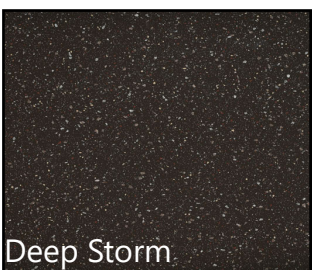
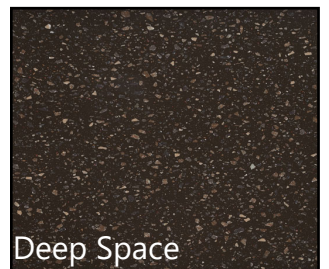
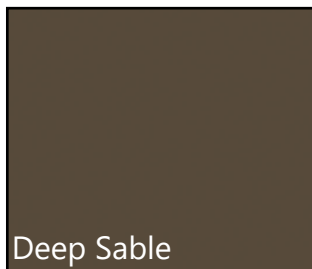
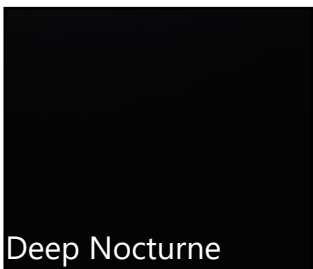
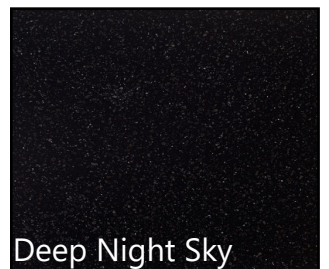
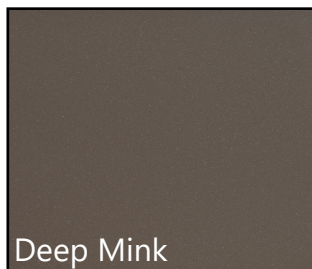
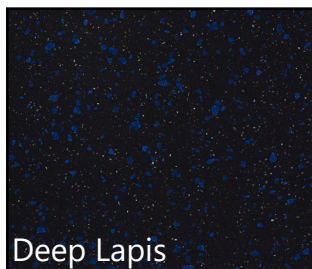
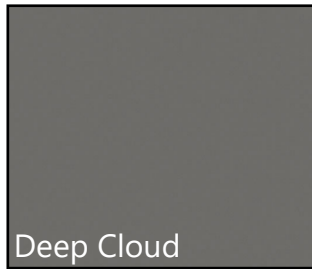
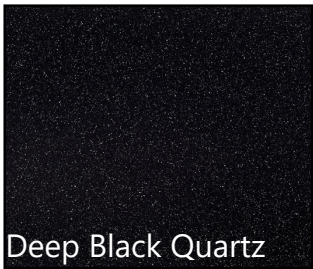
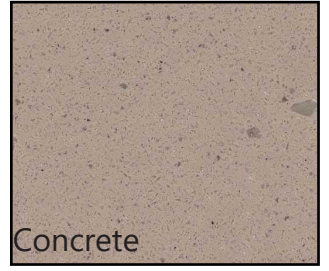
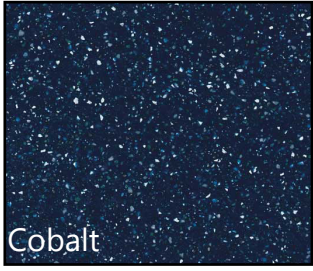

DuPont Corian Finishes

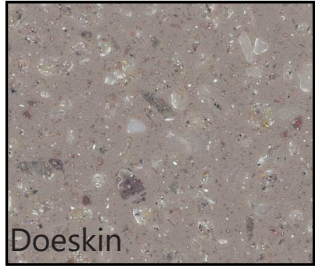

Doeskin



Dove



Dune Prima

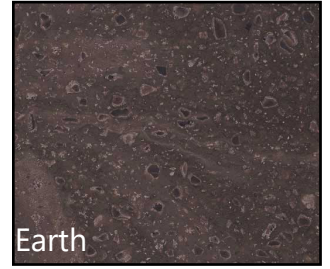

Earth

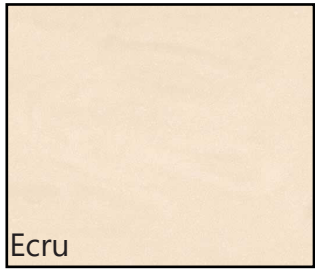

Ecru

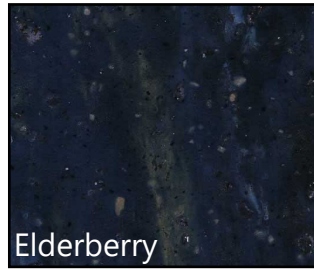

Elderberry



Elegant Gray



Evening Prima



Everest

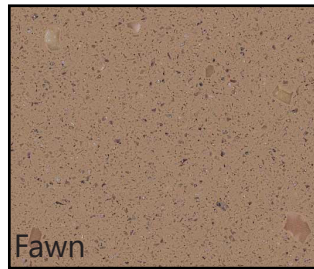

Fawn

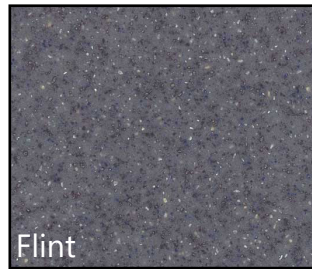

Flint

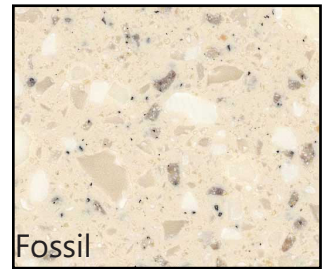

Fossil

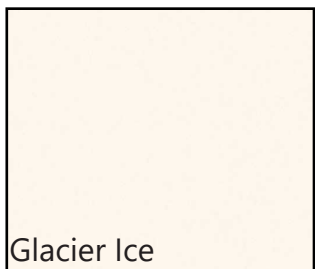

Glacier Ice

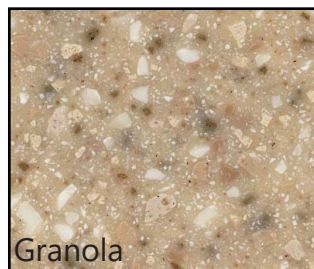

Granola

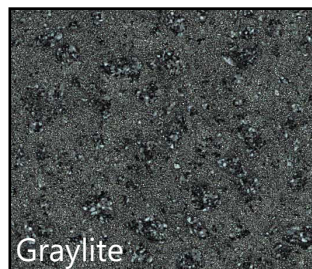

Graylite

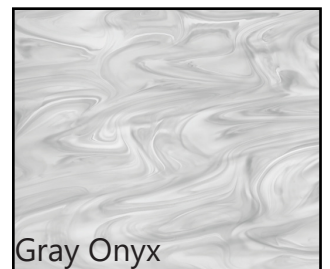

Gray Onyx



Hazelnut



Hickory Smoke



Jasmine

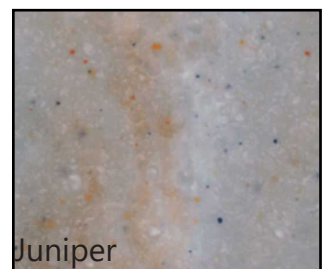

Juniper



Lava Rock



Limestone Prima

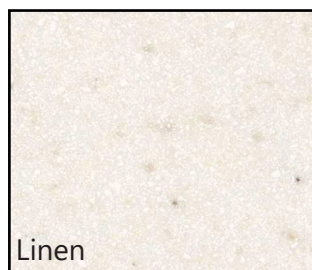

Linen



Matterhorn

DuPont Corian Finishes

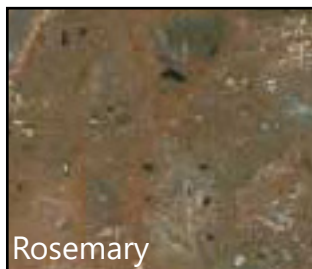
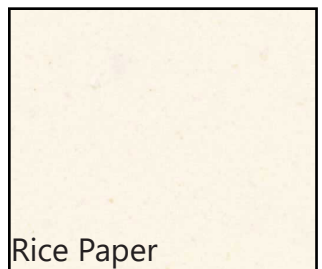
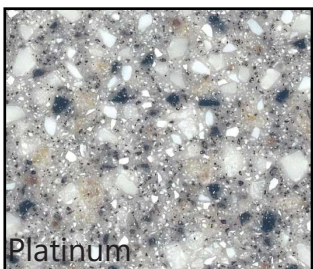
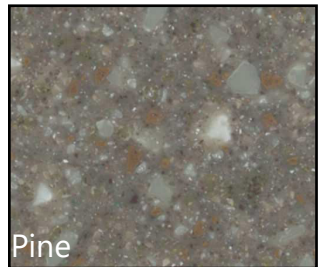
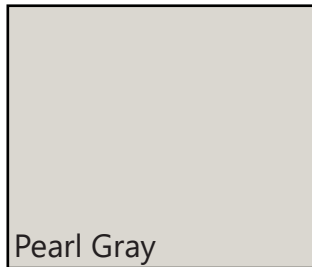
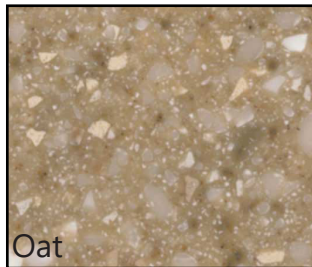
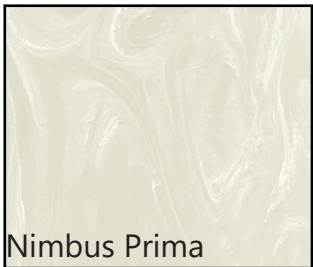
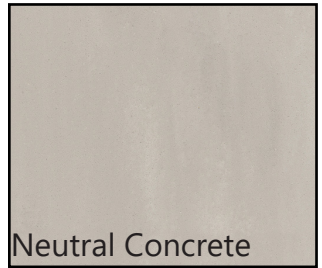
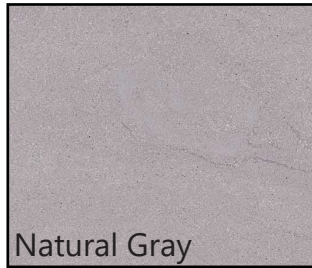
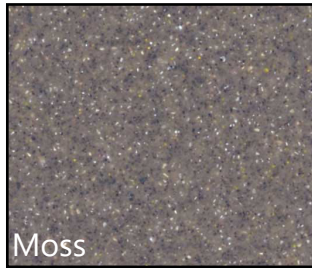
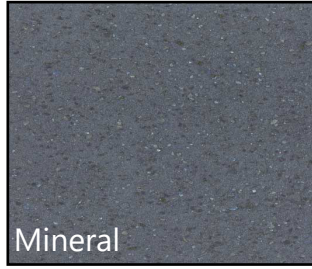
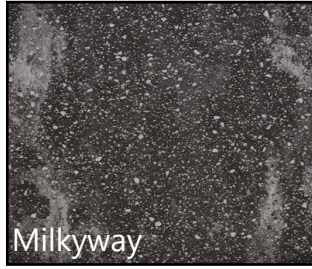
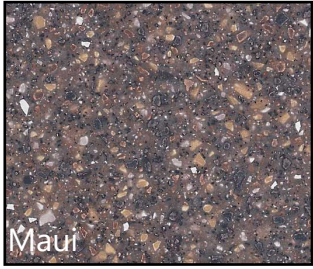

DuPont Corian Finishes



Sandstone



Sandstorm



Savannah



Seafoam

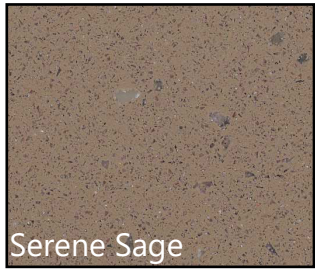

Serene Sage



Silt



Silver Birch



Silver Gray

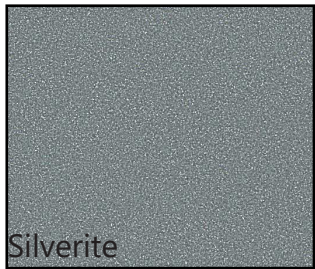

Silverite



Smokedrift Prima

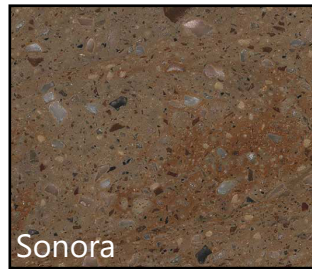

Sonora



Sorrel



Sparkling White



Stardust

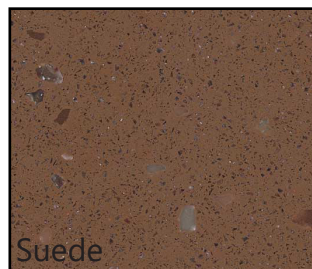

Suede



Tumbleweed

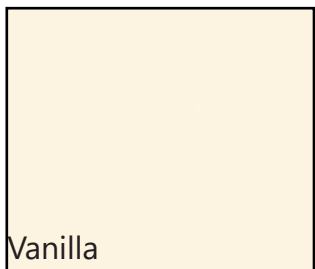

Vanilla

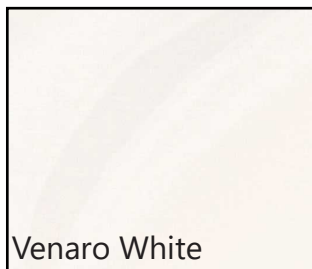

Venaro White

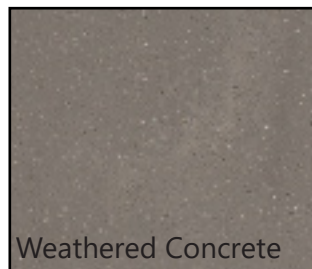

Weathered Concrete



Whipped Cream



Whisper

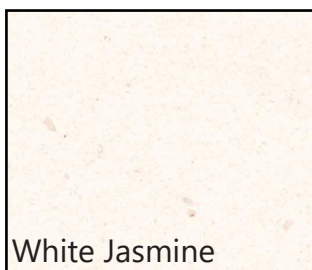

White Jasmine



White Onyx

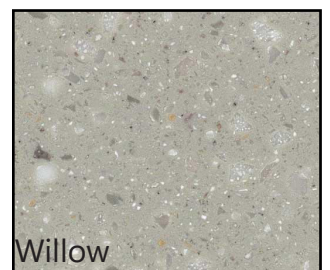

Willow

Intellicare Dining Tables Price List



Height Adjustable 4-User

Series	Size (W x D x H)	Code	List Price
Dining	42"x42"x28"-38"	H100/MULTI/4	\$3170

Available in all Intellicare laminates
Base available in black or silver



Height Adjustable 2-User

Series	Size (W x D x H)	Code	List Price
Dining	44"x32"x28"-38"	H100/MULTI/2	\$2583

Available in all Intellicare laminates
Base available in black or silver



Laminate Top with Scalloped Wood Edge , Legs & Skirt

Series	Size (W x D x H)	Code	List Price
Dining	36"x36"x29.5"	HDT/SWE/3636	\$1300
Dining	42"x42"x29.5"	HDT/SWE/4242	\$1410
Dining	30"x60"x29.5"	HDT/SWE/3060	\$1390
Dining	36"x72"x29.5"	HDT/SWE/3672	\$1485

Available in all Intellicare laminates
For wood finishes see w.1
Also available as a coffee or end table

Intellicare Dining Tables Price List



All Wood

Series	Size (W x D x H)	Code	List Price
Dining	42"x42"x29.5"	HDT/AW/4242	\$1960

For wood finishes see w.2
Also available as a coffee or end table



Traditional Wood Base with Laminate Top

Series	Size (W x D x H)	Code	List Price
Dining	36"x36"x29.5"	HDT/TLAM/3636	\$1456
Dining	42"x42"x29.5"	HDT/TLAM/4242	\$1572

Available with a square or round top
Available in all Intellicare laminates
For wood finishes see w.2



Queen Anne Style with Laminate Top, Wood Edge, Legs & Skirt

Series	Size (W x D x H)	Code	List Price
Dining	36"x36"x29.5"	HDT/QA/3636	\$1410
Dining	42"x42"x29.5"	HDT/QA/4242	\$1455
Dining	30"x60"x29.5"	HDT/QA/3060	\$1480
Dining	36"x72"x29.5"	HDT/QA/3672	\$1590

Available in all Intellicare laminates
For wood finishes see w.1
Also available as a coffee or end table

Intellicare Dining Tables Price List



Cast Iron with Laminate Top

Series	Size (W x D x H)	Code	List Price
Dining	36"x36"x29.5"	HDT/CASTLAM/3636	\$690
Dining	42"x42"x29.5"	HDT/CASTLAM/4242	\$767

Available with a square or round top
Available in all Intellicare laminates



Half Round with Laminate Top

Series	Size (W x D x H)	Code	List Price
Dining	36"x36"x29.5"	HDT/HRLAM/3636	\$1300
Dining	42"x42"x29.5"	HDT/HRLAM/4242	\$1410

Available with a square or round top
Available in all Intellicare laminates
Base Available in Black or Silver



Laminate with Post Legs

Series	Size (W x D x H)	Code	List Price
Dining	36"x36"x29.5"	SPL36	\$551
Dining	42"x42"x29.5"	SPL42	\$640
Dining	30"x60"x29.5"	REPL3060	\$695
Dining	36"x72"x29.5"	REPL3672	\$729

Available in All Intellicare Laminates
Base Available in Black or Silver
Also available as a coffee or end table

Intellicare Dining Tables Price List

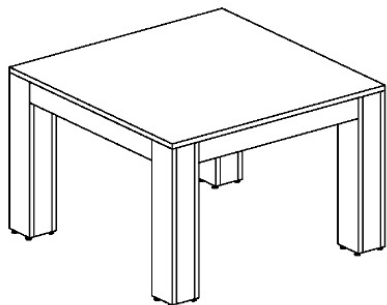

All Laminate

Series	Size (W x D x H)	Code	List Price
Dining	48"x48"x31"	HDT/LAM/4848	\$690

Available in all Intellicare laminates
Also available as a coffee or end table



42" Square Laminate Table (1.5" Top) with Laminate Pedestal Base

Series	Size (W x D x H)	Code	List Price
Dining	42"x42"x29.5"	HDT/LAMPED/4242	\$999

Available in all Intellicare laminates
Also available as a coffee or end table



42" Square Laminate Table with 4 Metal Legs & Laminate Skirt

Series	Size (W x D x H)	Code	List Price
Dining	42"x42"x29.5"	HDT/LAM/4METLEG/LAMSKRT/4242	\$1078

Available in all Intellicare laminates
Legs Available in Black or Silver
Also available as a coffee or end table

Intellicare Dining Tables Price List



100 Series Over Bed Table

Series	Size (W x D x H)	Code	List Price
Dining	30.5"x15x30"-47"	H/OBT100	\$515

Available in all Standard Intellicare Finishes



200 Series Over Bed Table

Series	Size (W x D x H)	Code	List Price
Dining	30"x15"x28"-45"	H/OBT200	\$1060

Available in select finishes



400 Series Over Bed Table

Series	Size (W x D x H)	Code	List Price
Dining	32"x18"x27"-42"	H/OBT400	\$1498

Available in all Standard Intellicare laminates

Wood Finishes W.1

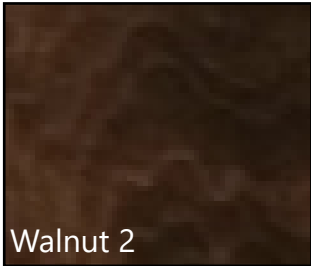
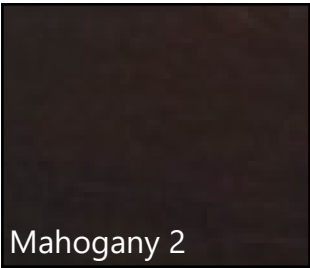

Wood Finishes W.2

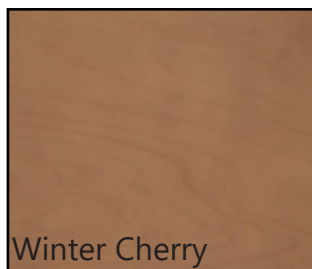
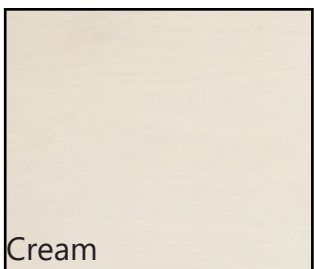
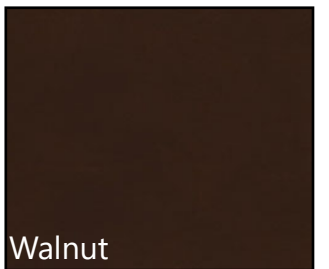
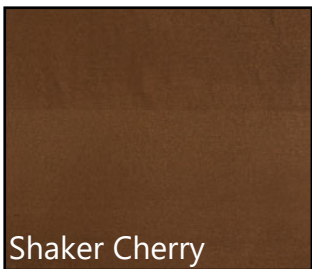
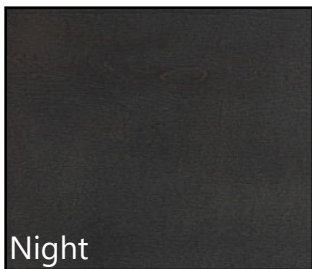
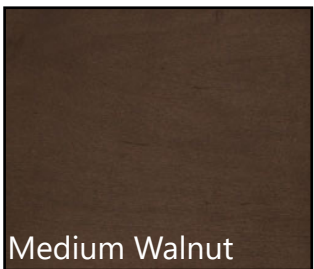
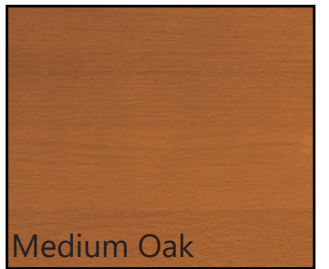
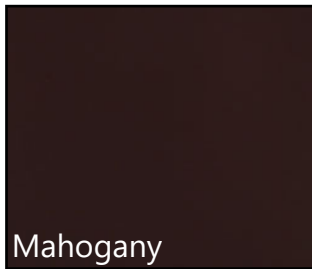
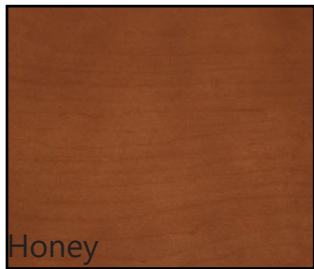
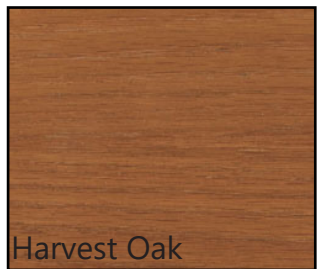
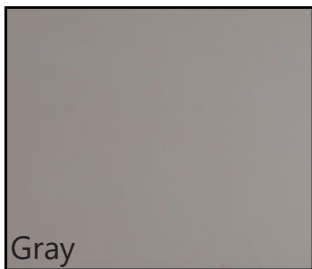
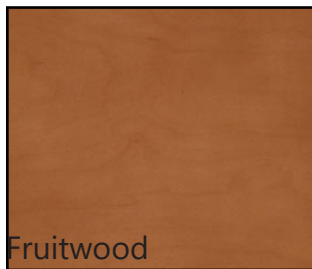
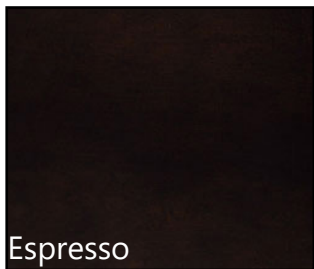
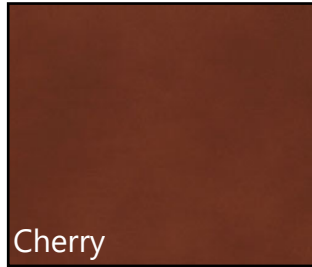
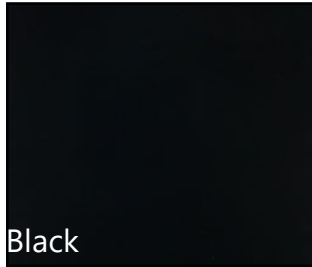
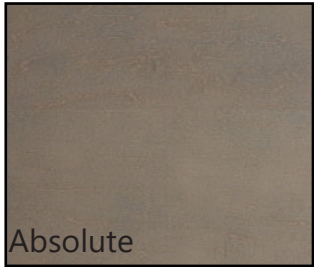

How to Order Casegoods



*The Image Above Shows A Custom Handle Placement

Product Code	→	H4/BT/2020/3DW/29
Finish - Top / Base	→	Top: Natural Maple / Base: Dark Rum
Top Style (If Applicable)	→	Top Style: 2
Front Style (If Applicable)	→	Front Style: B
Kickplate Style	→	Kickplate: Angled
Handle style and finish	→	Handle: Straight Silver

Finish	Handle Style	Top Style	Front Style	Kickplate Style
White. White Chocolate. Hard Rock Maple.	Straight (Silver & Black)	Style 1 - 1/8" Radius	Front Style A	Square
Natural Maple. Beige. Latitude. Grigo. Candlelight. Cappuccino Cherry. Summerflame. Dark Rum. Brunito Cherry.	Flat Loop (Silver & Brass)	Style 2 - 1/4" Radius	Front Style B	Angled
Wild Pear. Shiraz Cherry. Chocolate Pear.	Flair (Silver)	Style 3 - 1/4" Ripple	Front Style C	Radius
Hot Fudge. Graphite. Southwest.	Bar (Silver)	Style 4 - 1/4" Wave	Front Style D	
Grey Likeatree. Light Grey.	Knob (Silver & Brass)		Front Style E	
	Bridge (Nickel)		Front Style F	
	Baton (Nickel)			
	Cube (Nickel)			
	Rail (Silver & Black)			
	Waterfall (Nickel & Black)			

Please Contact Customer Service for Ordering Assistance

Email:

info@intellicarefurniture.com

Phone:

905-672-0942 ex.61

Toll Free:

1-800-764-2392

Intellicare Seating Price List

Wood Frame Dining Chairs



HCH245

- COM 1 Yard
- Wood Frame Dining Chair with Arms
- Upholstered Seat
- Upholstered Back
- Add Casters to Front Legs+\$47 List
- Mortise & Tendon Frame Construction with Tongue & Groove Corner Blocks

Fabric	List Price
COM	\$765



HCH980

- COM 1 Yard
- Wood Frame Dining Chair with Arms
- Upholstered Seat
- Upholstered Back
- Mortise & Tendon Frame Construction with Tongue & Groove Corner Blocks

Fabric	List Price
COM	\$797



HCH394

- COM 2 Yards
- Wood Frame Dining Chair with Arms
- Upholstered Seat
- Upholstered Back

Fabric	List Price
COM	\$1065



HCH605

- COM 1.5 Yards
- Wood Frame Dining Chair with Arms
- Upholstered Seat
- Upholstered Back
- Stackable

Fabric	List Price
COM	\$1440

Intellicare Seating Price List

Wood Frame Dining Chairs



HCH1579

- COM 1.25 Yards
- Wood Frame Dining Chair with Arms
- Wrapped Upholstered Seat
- Upholstered Back
- Back Side of Back is Wood
- Mortise & Tendon Frame Construction with Tongue & Groove Corner Blocks

Fabric	List Price
COM	\$908



HCH1400

- COM 1.5 Yards
- Wood Frame Dining Chair with Arms
- Upholstered Seat
- Upholstered Back
- Mortise & Tendon Frame Construction with Tongue & Groove Corner Blocks

Fabric	List Price
COM	\$1268



HCH1401

- COM 1.5 Yards
- Wood Frame Dining Chair with Arms
- Upholstered Seat
- Upholstered Back
- Mortise & Tendon Frame Construction with Tongue & Groove Corner Blocks

Fabric	List Price
COM	\$1545



HCH154

- COM 1.1 Yards
- Wood Frame Dining Chair with Arms
- Upholstered Seat
- Upholstered Back
- Mortise & Tendon Frame Construction with Tongue & Groove Corner Blocks

Fabric	List Price
COM	\$871

Intellicare Seating Price List

Wood Frame Dining Chairs



HCH4581

- COM 1 Yard
- Wood Frame Dining Chair with Arms
- Upholstered Seat
- Upholstered Back
- Seat is Removable with Plastic Knob
- Mortise & Tendon Frame Construction with Tongue & Groove Corner Blocks

Fabric	List Price
COM	\$814

Intellicare Seating Price List

Aluminum Frame Dining Chairs



HCHM3866

	Fabric	List Price
<ul style="list-style-type: none"> • COM 1 Yard • Aluminum Frame Dining Chair with Arms • Upholstered Seat • Upholstered Back • Wood Look Finish is Available at No Up-charge • Stacks 5 high 	COM	\$707



HCHM3728

	Fabric	List Price
<ul style="list-style-type: none"> • COM 1.5 Yards • Aluminum Frame Dining Chair with Arms • Upholstered Seat • Upholstered Back • Wood Look Finish is Available at No Up-charge • Stacks 5 high 	COM	\$707



HCHM3874

	Fabric	List Price
<ul style="list-style-type: none"> • COM 1.5 Yards • Aluminum Frame Dining Chair with Arms • Upholstered Seat • Upholstered Back • Wood Look Finish is Available at No Up-charge • Stacks 5 high 	COM	\$870



HCHM3850

	Fabric	List Price
<ul style="list-style-type: none"> • COM 1 Yard • Aluminum Frame Dining Chair with Arms • Upholstered Seat • Upholstered Back • Wood Look Finish is Available at No Up-charge • Stacks 5 High 	COM	\$707

Intellicare Seating Price List

Aluminum Frame Dining Chairs



HCHM3854

	Fabric	List Price
<ul style="list-style-type: none"> • COM 1.3 Yards • Aluminum Frame Dining Chair with Arms • Upholstered Seat • Upholstered Back • Wood Look Finish is Available at No Up-charge • Stacks 5 high 	COM	\$767



HCHM3770

	Fabric	List Price
<ul style="list-style-type: none"> • COM 1 Yard • Aluminum Frame Dining Chair with Arms • Upholstered Seat • Upholstered Back • Wood Look Finish is Available at No Up-charge • Stacks 5 high 	COM	\$767



HCHM3849

	Fabric	List Price
<ul style="list-style-type: none"> • COM 1.5 Yards • Aluminum Frame Dining Chair with Arms • Upholstered Seat • Upholstered Back • Wood Look Finish is Available at No Up-charge 	COM	\$986



HCHM3772

	Fabric	List Price
<ul style="list-style-type: none"> • COM 1 Yard • Aluminum Frame Dining Chair with Arms • Upholstered Seat • Upholstered Back • Wood Look Finish is Available at No Up-charge • Stacks 5 high 	COM	\$720

Intellicare Seating Price List

Aluminum Frame Dining Chairs



HCHM3812

- COM 1.3 Yards
- Aluminum Frame Dining Chair with Arms
- Upholstered Seat
- Upholstered Back
- Wood Look Finish is Available at No Up-charge

Fabric	List Price
COM	\$939



HCHM3736

- COM 1 Yard
- Aluminum Frame Dining Chair with Arms
- Upholstered Seat
- Upholstered Back
- Wood Look Finish is Available at No Up-charge
- Stacks 5 high

Fabric	List Price
COM	\$939



HCHM3872

- COM 1.5 Yards
- Aluminum Frame Dining Chair with Arms
- Upholstered Seat
- Upholstered Back
- Wood Look Finish is Available at No Up-charge

Fabric	List Price
COM	\$939



HCHM3864

- COM 1 Yard
- Aluminum Frame Dining Chair with Arms
- Upholstered Seat
- Upholstered Back
- Wood Look Finish is Available at No Up-charge
- Stacks 5 high

Fabric	List Price
COM	\$814

Intellicare Seating Price List

Lounge Chairs



HCH220

- COM 2.5 Yards
- Wood Frame Dining Chair with Arms
- Upholstered Seat
- Fully Upholstered Back

Fabric	List Price
COM	\$1407



HCH184

- COM 3 Yards
- Wood Frame Wing Back Dining Chair

Fabric	List Price
COM	\$1299



HCH169

- COM 3 Yards
- Wood Frame Wing Back Dining Chair

Fabric	List Price
COM	\$1141



HLC168

- COM 5 Yards
- Wood Frame Lounge Chair with Arms

Fabric	List Price
COM	\$1188

Intellicare Seating Price List

Lounge Chairs



HLC101

Fabric	List Price
COM	\$1545

- COM 5 Yards
- Wood Frame Lounge Chair with Arms



HLC109

Fabric	List Price
COM	\$1185

- COM 5 Yards
- Wood Frame Lounge Chair with Arms



HLC557

Fabric	List Price
COM	\$2143

- COM 3.5 Yards
- Wood Frame Lounge Chair with Arms



HLC456

Fabric	List Price
COM	\$1383

- COM 1.5 Yards
- Wood Frame Lounge Chair with Arms

Intellicare Seating Price List

Lounge Chairs



HLC26

Fabric	List Price
COM	\$893

- COM 2 Yards
- Wood Frame Paitent Chair with Arms
- Add \$75 for Upholstered Arm Caps (Shown)



HLC100

Fabric	List Price
COM	\$1393

- COM 1.6 Yards
- Wood & Metal Frame Paitent Chair with Arms



HLC554

Fabric	List Price
COM	\$2581

- COM 5.5 Yards
- Wood Frame Lounge Chair with Arms



HLC144

Fabric	List Price
COM	\$1200

- COM 6 Yards
- Wood Frame Lounge Chair with Arms

Intellicare Seating Price List

Lounge Chairs



HLC242

- COM 6.5 Yards
- Wood Frame Lounge Chair with Arms
- Loveseat & sofa available
- Optional cleanout
- Optional moisture barrier
- Mortise & Tendon Frame Construction with Tongue & Groove Corner Blocks

Fabric	List Price
COM	\$1814



HLC236

- COM 6.5 Yards
- Wood Frame Lounge Chair with Arms
- Loveseat & sofa available
- Optional cleanout
- Optional moisture barrier
- Mortise & Tendon Frame Construction with Tongue & Groove Corner Blocks

Fabric	List Price
COM	\$1814



HLC285

- COM 8 Yards
- Wood Frame Lounge Chair with Arms
- Loveseat & sofa available
- Optional cleanout
- Optional moisture barrier
- Mortise & Tendon Frame Construction with Tongue & Groove Corner Blocks

Fabric	List Price
COM	\$1814



HLC720

- COM 6 Yards
- Wood Frame Lounge Chair with Arms
- Loveseat & sofa available
- Optional cleanout
- Optional moisture barrier
- Mortise & Tendon Frame Construction with Tongue & Groove Corner Blocks

Fabric	List Price
COM	\$1704

Intellicare Seating Price List

Lounge Chairs



HLC754

Fabric	List Price
COM	\$1736

- COM 5 Yards
- Wood Frame Lounge Chair with Arms



HLC147

Fabri	List Price
COM	\$1188

- COM 5 Yards
- Wood Frame Wing Back-Lounge Chair with Arms



HLC285

Fabric	List Price
COM	\$1736

- COM 5 Yards
- Wood Frame Wing Back-Lounge Chair with Arms



HLC752

Fabric	List Price
COM	\$1736

- COM 5 Yards
- Wood Frame Lounge Chair with Arms

Intellicare Seating Price List

Patient Room Seating



HLCR4115

Fabric	List Price
COM	\$5321

- COM 6.45 Yards
- 3 Position Recliner
- Closed Arm
- Dual Density Foam



HLCS0106

Fabric	List Price
COM	\$6182

- COM 7.5 Yards
- Sleeper Chair
- Closed Arm
- Dual Density Foam



HLCR2220

Fabric	List Price
COM	\$2051

- COM 8 Yards
- Wing Back Recliner Chair with Wood Legs
- Mortise & Tendon Frame Construction with Tongue & Groove Corner Blocks



HLCR9754

Fabric	List Price
COM	\$2229

- COM 5 Yards
- Recliner Chair with Wood Legs

Intellicare Seating Price List

Office Chairs



HCHO88009

	Fabric	List Price
<ul style="list-style-type: none"> • COM .75 Yards • Mid-Back • Synchro-Tilt Mechanism • Black Nylon Base • Task Arms • Black Mesh 	COM	\$723



HCHO98077

	Fabric	List Price
<ul style="list-style-type: none"> • COM .75 Yards • Mid-Back • Synchro-Tilt Mechanism • Height Adjustable arms • Black Nylon Base • Black Mesh • Hard Surface Casters 	COM	\$886
		+\$52 List



HCHO71025

	Fabric	List Price
<ul style="list-style-type: none"> • COM 1.75 Yards • Mid-Back • Swivel-Tilt Mechanism • Black Nylon Base • Adjustable Kidney Arms • Hard Surface Casters 	COM	\$905
		+\$49 List



HCHO98177

	Fabric	List Price
<ul style="list-style-type: none"> • COM .75 Yards • High-Back • Synchro-Tilt Mechanism • Height Adjustable arms • Black Nylon Base • Black Mesh • Hard Surface Casters 	COM	\$942
		+\$52 List

Intellicare Seating Price List

Office Chairs



HCHO02072

	Fabric	List Price
<ul style="list-style-type: none"> • COM 1.75 Yards • Mid-Back • Swivel-Tilt Mechanism • Black Nylon Base • Conference Arms • Hard Surface Casters + \$49 List 	COM	\$977



HCHO71125

	Fabric	List Price
<ul style="list-style-type: none"> • COM 2 Yards • High-Back • Swivel-Tilt Mechanism • Height Adjustable arms • Black Nylon Base • Hard Surface Casters + \$49 List 	COM	\$1033



HCHO64184

	Fabric	List Price
<ul style="list-style-type: none"> • COM 1 Yard • High-Back • Synchro-Tilt Mechanism • Black Nylon Base • Height Adjustable Arms • Hard Surface Casters + \$52 List 	COM	\$1127



HCHO04096

	Fabric	List Price
<ul style="list-style-type: none"> • COM 1.5 Yards • Mid-Back • Synchro-Tilt Mechanism • Height Adjustable arms • Black Nylon Base • Hard Surface Casters + \$49 List 	COM	\$1168

Intellicare Seating Price List

Office Chairs



HCHO04074

	Fabric	List Price
<ul style="list-style-type: none"> • COM .75 Yards • Mid-Back • Synchro-Tilt Mechanism • Black Nylon Base • Height Adjustable Arms • Black Mesh • Hard Surface Casters • +\$52 List 	COM	\$1199



HCHO03155

	Fabric	List Price
<ul style="list-style-type: none"> • COM 1.75 Yards • High-Back • Posture Back Mechanism • Black Nylon Base • Height Adjustable Arms • Hard Surface Casters • +\$49 List 	COM	\$1299



HCHO641464

	Fabric	List Price
<ul style="list-style-type: none"> • COM 1.75 Yards • High-Back • Synchro-Tilt Mechanism • Height Adjustable arms • Black Nylon Base • Hard Surface Casters • +\$52 List 	COM	\$1368



HCHO03355

	Fabric	List Price
<ul style="list-style-type: none"> • COM 1.5 Yards • Extra High-Back • Posture Back Mechanism • Height Adjustable arms • Black Nylon Base • Hard Surface Casters • +\$49 List 	COM	\$1465

Intellicare Seating Price List

Office Chairs



HCHO04029

- COM 2.0 Yards
- Mid-Back
- Synchro-Tilt Mechanism
- Black Nylon Base
- Conference Arms
- Hard Surface Casters
- +\$49 List

Fabric	List Price
COM	\$1487



HCHO21048

- COM .75 Yards
- Mid-Back
- Synchro-Tilt Mechanism
- Black Aluminum Base
- Black Mesh
- Height Adjustable Arms
- Hard Surface Casters
- +\$52 List

Fabric	List Price
COM	\$1866



HCHO21148

- COM .75 Yards
- High-Back
- Synchro-Tilt Mechanism
- Height Adjustable arms
- Black Aluminum Base
- Black Mesh
- Hard Surface Casters
- +\$52 List

Fabric	List Price
COM	\$1891



HCHO53112

- COM 2 Yards
- High-Back
- Knee-Tilt Mechanism
- Fixed Aluminum Arms
- Aluminum Base
- Hard Surface Casters
- +\$155 List

Fabric	List Price
COM	\$2154

Intellicare Seating Price List

Metal Frame Guest Chairs



HCHM184

Fabric	List Price
COM	\$304

- COM 1 Yard
- Metal Tube Frame
- Armless



HCHM185

Fabric	List Price
COM	\$330

- COM .50 Yards
- Metal Tube Frame
- With Arms

Intellicare Seating Fabric Offering

Pattern	Vendor	\$/Yard
Quarry	J. Ennis	\$8.50
Turner	J. Ennis	\$10.50
Windsong 2	J. Ennis	\$16.55
Tradewinds Plus	J. Ennis	\$16.95
Premier Vinyl	J. Ennis	\$16.95
Tribeca	Master Fabrics	\$20.01
Comfy	Master Fabrics	\$20.74
Snuggle	Master Fabrics	\$20.74
Lafayette	Master Fabrics	\$21.47
Surrey	J. Ennis	\$21.50
Rogue II	J. Ennis	\$21.50
Surfside	J. Ennis	\$21.50
Apex	J. Ennis	\$22.50
Chamea II	J. Ennis	\$22.75
Manhattan	Master Fabrics	\$22.94
Nauga Soft	J. Ennis	\$24.00
Neochrome III	J. Ennis	\$24.25
Spirit Millennium	J. Ennis	\$24.25
Avalon	J. Ennis	\$24.95
Houston	Master Fabrics	\$25.13
Broadway	Master Fabrics	\$25.86
Esprit	Master Fabrics	\$25.86
Casablanca	J. Ennis	\$26.25
Poetry	Master Fabrics	\$27.00
Upper	Master Fabrics	\$27.32
Stratosphere	J. Ennis	\$28.50
Pollen	J. Ennis	\$28.50
Reflect	J. Ennis	\$28.50
Silververtex	J. Ennis	\$29.50
Imagine	J. Ennis	\$30.00
Glam	J. Ennis	\$30.00
Influence	J. Ennis	\$30.00
Movement	J. Ennis	\$30.00
Stimulate	J. Ennis	\$30.00
Wicker	J. Ennis	\$30.00
Reflex	J. Ennis	\$30.50

Additional Fabrics Can Be Obtained From: Maharam, Momentum, Arc Com, Robert Allen, CF Stinson, Mayer, Fabricut, Morbern (MorCare)
Please Contact Your Representative for More Information.

***Fabric orders under 10 yards are subject to a \$10 shipping fee.**

Tribeca

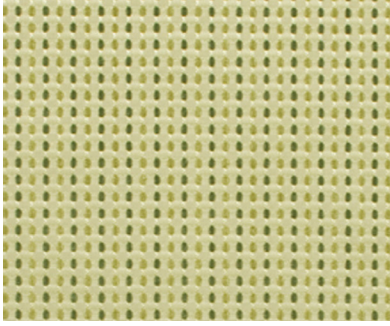

003

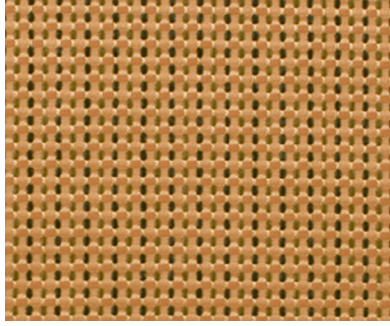

084

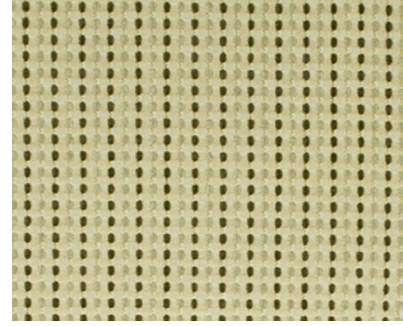

206

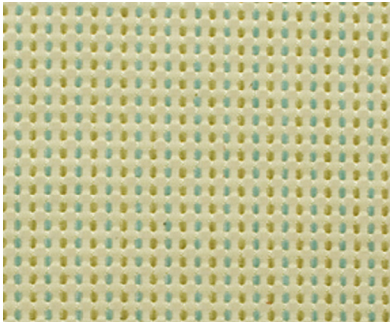

224

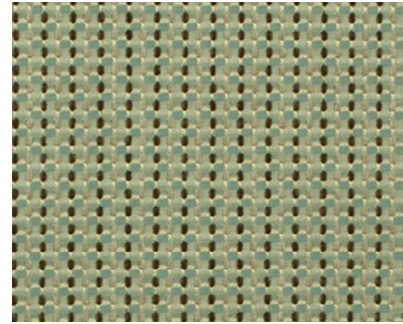

522

Specifications

Width: 54"/137 cm

Contents: 100% Polyester

Repeat: V: 1"/2 cm

Weight: 300g/m², 14.3 oz/linear yards

Seam Slippage/ASTM-D 4034: Warp 134.3 lbs., fill 124.9 lbs

Breaking Strength/ASTM D-5034: Warp 293 lbs, fill 203 lbs

Color Fastness to Light/AATCC-8: 4

Color Fastness to Crocking/AATCC-8: Wet 4.5, Dry 4.5

Abrasion Resistance/ASTM D-4157-02: 50,000 double rubs duck cloth

Brush Pilling Test/ASTM D-3511: Class 4

Cleaning Code: WS

Flammability/State of California Technical Bulletin 117, Section E (CS-191-53): Passed

UFAC: Class 1

Shown Railroaded

Comfy



001

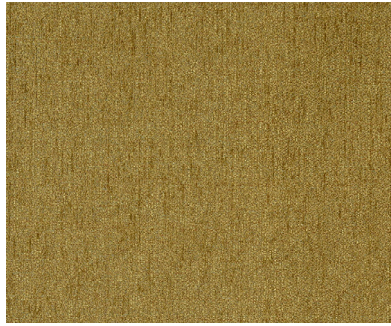

002



006

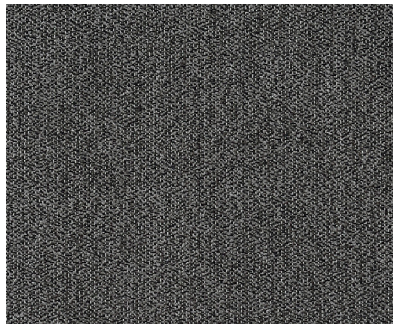

059



061



084



304



640

Specifications

Width: 54"/137 cm

Contents: 100% Polyester

Repeat: N/A

Weight: 19.3 oz/ linear yard

Backing: acrylic

Seam Slippage/ASTM-D 4034: Warp 72 lbs., fill 46 lbs

Breaking Strength/ASTM D-5034: Warp 183 lbs, fill 149 lbs

Color Fastness to Light/AATCC-16 (40 Hours): 3.5

Color Fastness to Crocking/AATCC-8: Wet 4.5, Dry 4.5

Abrasian Resistance/ASTM D-4157: 60,000 double rubs

Brush Pilling Test/ASTM D-3511: Class 4

Cleaning Code: WS

Flammability/State of California Technical Bulletin 117, Section E (CS-191-53): Passed

NFPA 260: Passed

UFAC: Class 1

Snuggle



003



002



006

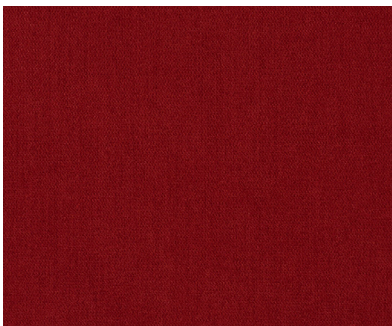

008



022



060



084

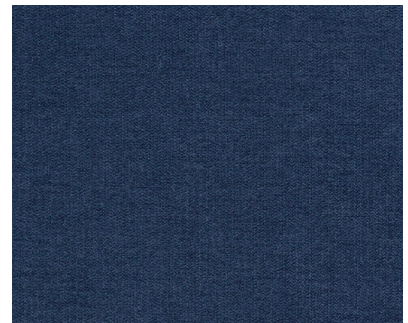

304

Specifications

Width: 54"/137 cm

Contents: 100% Polyester

Repeat: N/A

Weight: 21 oz/ linear yard

Backing: laminated

Seam Slippage/ASTM-D 4034: Warp 105 lbs., fill 100 lbs

Breaking Strength/ASTM D-5034: Warp 270 lbs, fill 197 lbs

Color Fastness to Light/AATCC-16 (40 Hours): 3

Color Fastness to Crocking/AATCC-8: Wet 4, Dry 4.5

Abrasion Resistance/ASTM D-4157: 100,000 double rubs

Brush Pilling Test/ASTM D-3511: Class 5

Cleaning Code: WS

Flammability/State of California Technical Bulletin 117, Section E (CS-191-53): Passed

NFPA 260: Passed

UFAC: Class 1

Broadway



002

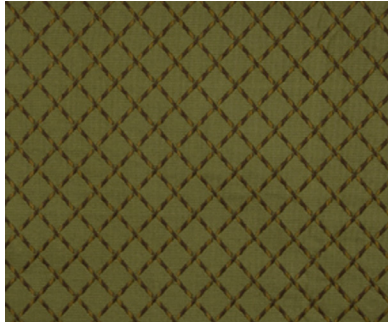

003

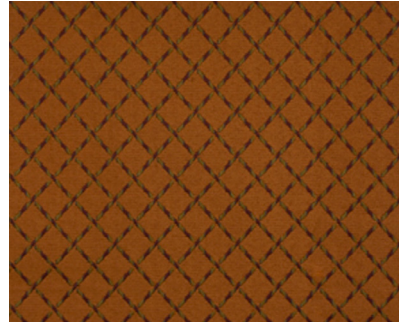

004



020



088

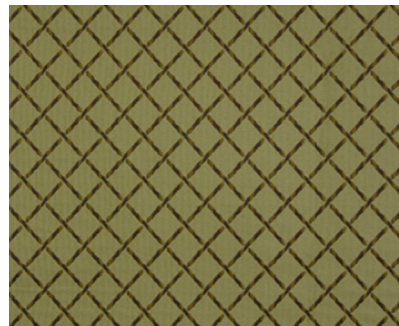

090

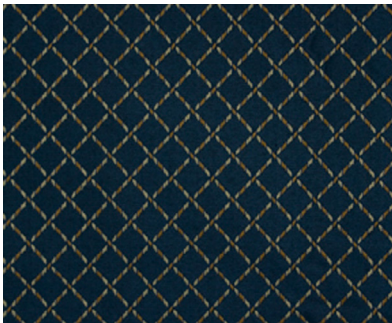

304

Specifications

Width: 54"/137 cm

Contents: 100% Polyester

Repeat: H: 1 1/4" 3cm, V: 1 1/4" 3cm

Weight: 215g/m², 10.6 oz/linear yards

Seam Slippage/ASTM-D 4034: Warp 109.6 lbs., fill 101.3 lbs

Breaking Strength/ASTM D-5034: Warp 316 lbs, fill 366 lbs

Color Fastness to Light/AATCC-8: 4

Color Fastness to Crocking/AATCC-8: Wet 4.5, Dry 4.5

Abrasion Resistance/ASTM D-4157-02: 55,000 double rubs

Brush Pilling Test/ASTM D-3511: Class 4

Cleaning Code: WS

Flammability/State of California Technical Bulletin 117, Section E (CS-191-53): Passed

UFAC: Class 1

Shown Railroaded

Manhattan

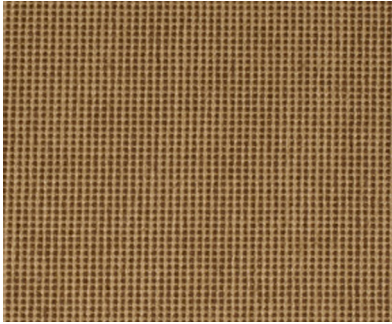

005

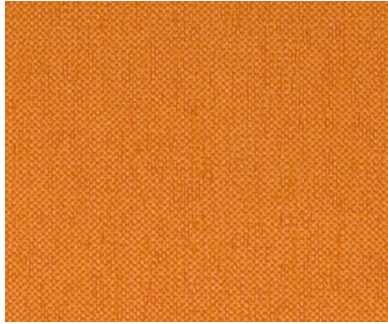

009



020

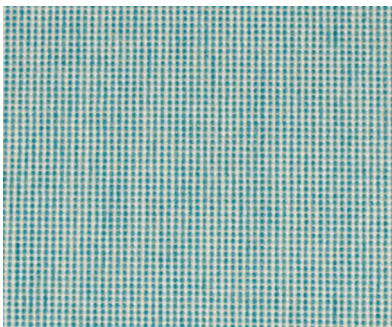

022

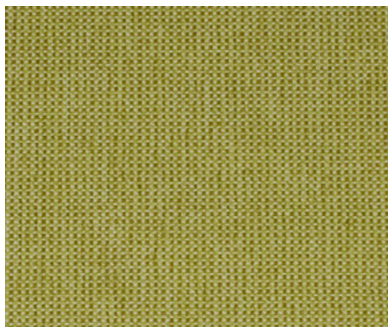

023

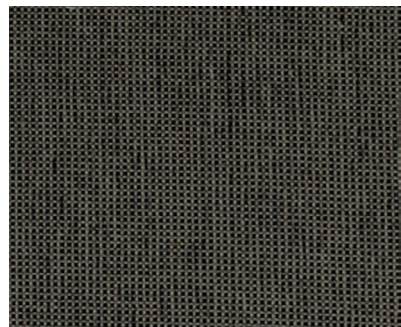

040



066



086



304

Specifications

Width: 54"/137 cm

Contents: 100% Polyester

Repeat: N/A

Weight: 387g/m², 18.3 oz/linear yards

Seam Slippage/ASTM-D 4034: Warp 31.4 lbs., fill 26.2 lbs

Breaking Strength/ASTM D-5034: Warp 304 lbs, fill 119 lbs

Color Fastness to Light/AATCC-8: 4

Color Fastness to Crocking/AATCC-8: Wet 4.5, Dry 4.5

Abrasion Resistance/ASTM D-4157-02: 50,000 double rubs

Brush Pilling Test/ASTM D-3511: Class 4

Cleaning Code: WS

Flammability/State of California Technical Bulletin 117, Section E (CS-191-53): Passed

UFAC: Class 1

Shown Railroaded

Lafayette



006



020



030



084



622

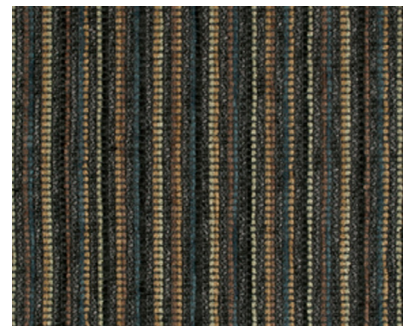

630

Specifications

Width: 54"/137 cm

Contents: 78% Polyester, 22% Cotton

Repeat: V: 1" 2cm

Weight: 580g/m², 27.6 oz/linear yards

Seam Slippage/ASTM-D 4034: Warp 134 lbs., fill 109.1 lbs

Breaking Strength/ASTM D-5034: Warp 287 lbs, fill 165 lbs

Color Fastness to Light/AATCC-8: 4.5

Color Fastness to Crocking/AATCC-8: Wet 4.5, Dry 4.5

Abrasian Resistance/ASTM D-4157-02: 50,000 double rubs

Brush Pilling Test/ASTM D-3511: Class 4

Cleaning Code: S

Flammability/State of California Technical Bulletin 117, Section E (CS-191-53): Passed

UFAC: Class 1

Shown Railroaded

Houston

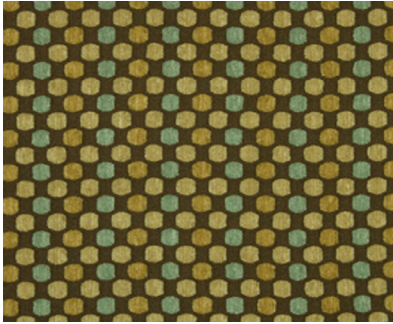

005

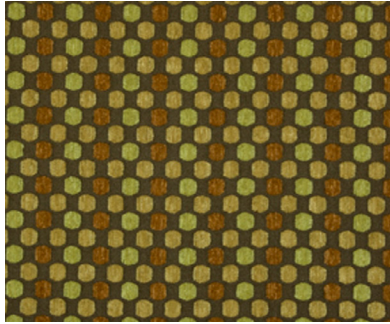

623

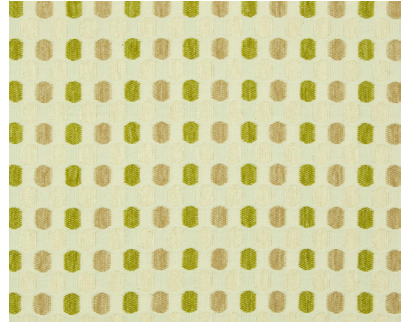

020

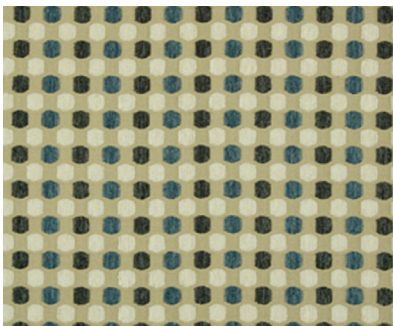

021



022



040

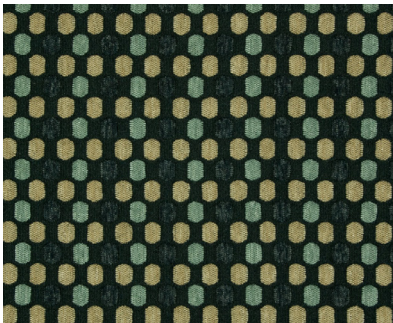

059

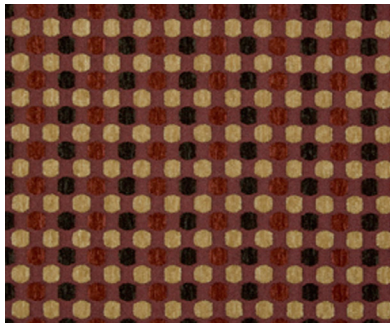

088

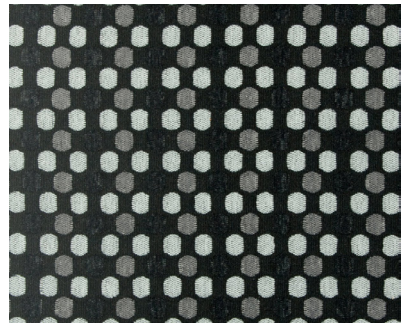

140

Specifications

Width: 54"/137 cm

Contents: 100% Polyester

Repeat: H:1" 2 cm, V" 1 1/2" 3.5 cm

Weight: 460g/m², 22.6 oz/linear yards

Seam Slippage/ASTM-D 4034: Warp 123 lbs., fill 47.4 lbs

Breaking Strength/ASTM D-5034: Warp 288 lbs, fill 202 lbs

Color Fastness to Light/AATCC-8: 4

Color Fastness to Crocking/AATCC-8: Wet 4.5, Dry 4.5

Abrasion Resistance/ASTM D-4157-02: 100,000 double rubs

Brush Pilling Test/ASTM D-3511: Class 4

Cleaning Code: WS

Flammability/State of California Technical Bulletin 117, Section E (CS-191-53): Passed

UFAC: Class 1

Shown Railroaded

Esprit Vinyl

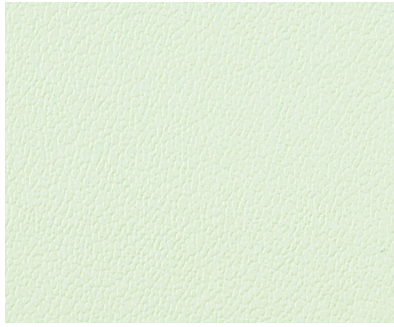

001



002



003



004

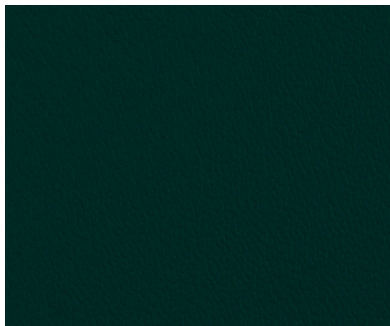

005



006

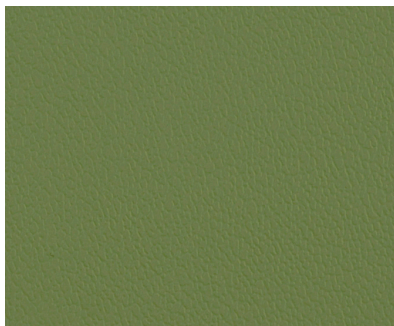

007

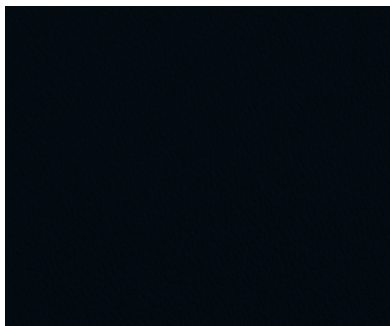

008

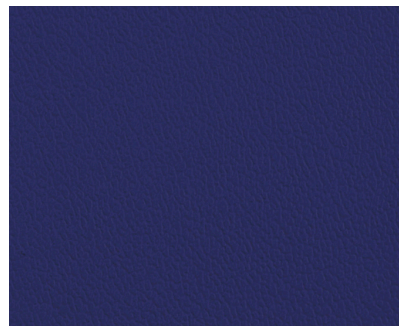

009

Specifications

Width: 54"

Weight: 30 oz/linear yard

Backing: 100% polyester knit

Abrasion Resistance: 250,000 double rubs per ASTM D4157-02 Wyzenbeek/CFFA-1A

Ultra Violet Resistance: 500 hours per ASTM D26-96 method c/CFFA-2

Cold Crack: -20°F per federal standard # 191A-method 5874 /CFFA-6

Anti-Bacterial: per AATCC-147 (2002)

Anti-Microbial: per ASTM G21-96 (2002)

Stain Resistance: per ResilienceSR

Flammability Requirements: California fire code technical bulletin #117 section e, BIFMA, UFAC class 1, NFPA 260,

MVSS 302, IMO A.652 (16) 8.2, Boston fire department code test BFD IX-1, Port Authority of New York/New Jersey

Cleaning: Prompt cleaning is always recommended. Ordinary dirt and stains can be removed with mild soap and

water. Rinse the cleaned area with clean water and dry with a lint free cloth. Esprit will resist, without serious

discoloration, the repeated actions of normal dilutions of non-abrasive chlorine or ammonia-based cleaners.

Esprit Vinyl



010



012



013



014



016



017

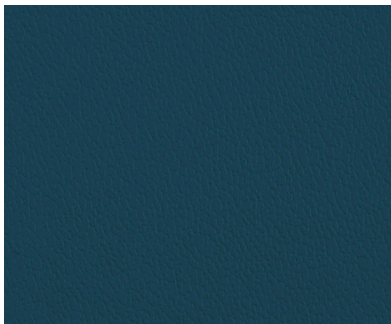

018

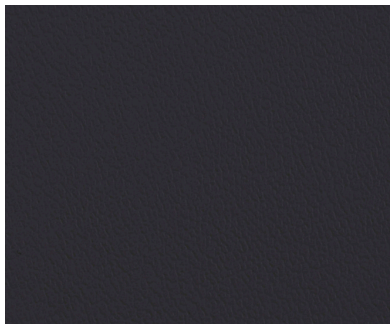

019



020

Specifications

Width: 54"

Weight: 30 oz/linear yard

Backing: 100% polyester knit

Abrasion Resistance: 250,000 double rubs per ASTM D4157-02 Wyzenbeek/CFFA-1A

Ultra Violet Resistance: 500 hours per ASTM D26-96 method c/CFFA-2

Cold Crack: -20°F per federal standard # 191A-method 5874 /CFFA-6

Anti-Bacterial: per AATCC-147 (2002)

Anti-Microbial: per ASTM G21-96 (2002)

Stain Resistance: per ResilienceSR

Flammability Requirements: California fire code technical bulletin #117 section e, BIFMA, UFAC class 1, NFPA 260,

MVSS 302, IMO A.652 (16) 8.2, Boston fire department code test BFD IX-1, Port Authority of New York/New Jersey

Cleaning: Prompt cleaning is always recommended. Ordinary dirt and stains can be removed with mild soap and

water. Rinse the cleaned area with clean water and dry with a lint free cloth. Esprit will resist, without serious

discoloration, the repeated actions of normal dilutions of non-abrasive chlorine or ammonia-based cleaners.

Esprit Vinyl



022

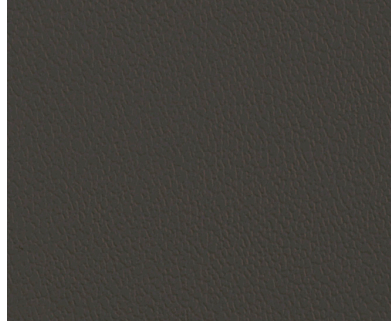

026

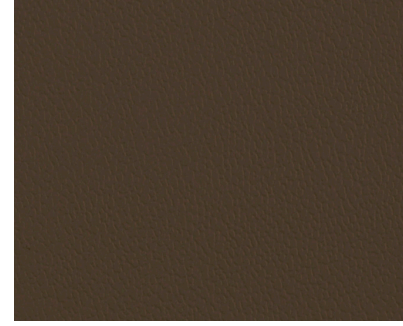

041



047



061



062

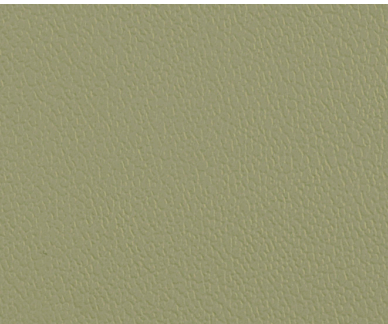

066

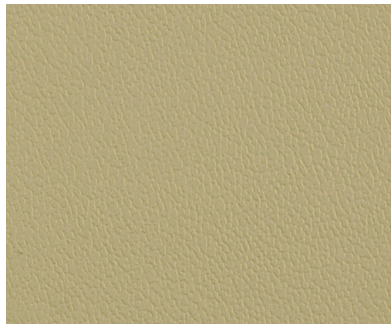

070

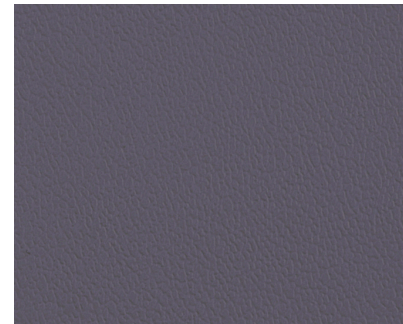

074

Specifications

Width: 54"

Weight: 30 oz/linear yard

Backing: 100% polyester knit

Abrasion Resistance: 250,000 double rubs per ASTM D4157-02 Wyzenbeek/CFFA-1A

Ultra Violet Resistance: 500 hours per ASTM D26-96 method c/CFFA-2

Cold Crack: -20°F per federal standard # 191A-method 5874 /CFFA-6

Anti-Bacterial: per AATCC-147 (2002)

Anti-Microbial: per ASTM G21-96 (2002)

Stain Resistance: per ResilienceSR

Flammability Requirements: California fire code technical bulletin #117 section e, BIFMA, UFAC class 1, NFPA 260,

MVSS 302, IMO A.652 (16) 8.2, Boston fire department code test BFD IX-1, Port Authority of New York/New Jersey

Cleaning: Prompt cleaning is always recommended. Ordinary dirt and stains can be removed with mild soap and

water. Rinse the cleaned area with clean water and dry with a lint free cloth. Esprit will resist, without serious

discoloration, the repeated actions of normal dilutions of non-abrasive chlorine or ammonia-based cleaners.

Imagine



37 Lagoon

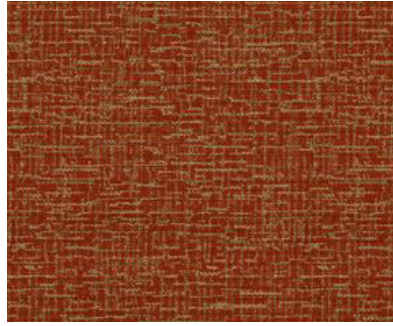

44 Pumpkin



51 Yellow



81 Sandalwood



205 Sprig



308 Navy



608 Linen



6009 Chinchilla



9009 Black

Specifications

Width: 55.250"

Abrasion: Exceeds 50,000 double rubs

Cleaning: Crypton upholstery cleaner cleanable with Virox 5. W-clean fabrics with water based cleaning agents or water based foam

Construction: Crypton jacquards woven

Content: 16% recycled post consumer polyester, 30% post industrial polyester, 54% polyester

Crocking: AATCC8: Wet class 4.5, dry class 5

Features: Bacterial/fungal resistant. Stain resistant Crypton is breathable as per ASTM96.

Crypton is engineered to provide permanent moisture, soil resistance and antimicrobial protection.

Fire Retardancy: California Bulletin 117-Section E, UFAC class 1

Product is mildew resistant

Pilling: Passes ASTM D3511 class 5

Protective Finish: Crypton

Repeat: Length 2.6", Width 1.9"

Seam Slippage: Passes seam slippage ASTM-D4034. F84 x W37 LBF

Tear Strength: Passes ASTM D2261. Warp 42 lbs, fill 25 lbs

Tensile Strength: Passes ASTM D5034. Warp 221 lbs, fill 170 lbs.

Ultraviolet: Lightfastness is 40 hours, colorfastness to light AATCC16 class 4

Weight: 10.22 oz/linear yard, 6.69 oz/sq. yard

Rogue II



RU710 Crimson



RU750 Indian Red



RU780 Blue

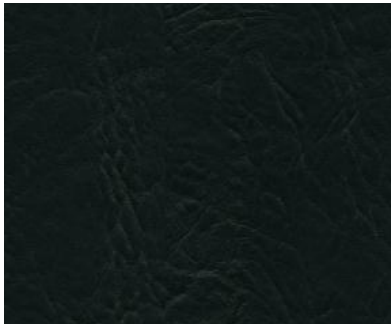

RU810 Black

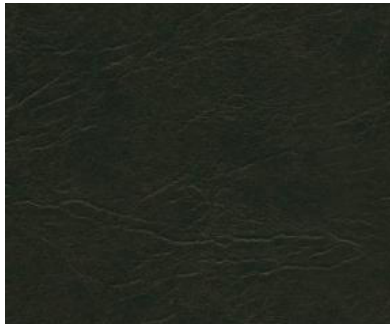

RU820 Walnut



RU840 Buckskin



RU870 Off White



RU880 Fawn



RU890 Tobacco

Specifications

Width: 54"

Abrasion: Exceeds 100,000 double rubs

Backing Content: 100% polyester

Cautions: White vinyl: dye transfer from clothing (especially blue jeans) onto white vinyl. This transfer is due to the wide range of dyes now being used in clothing coming from different countries. This is not a defect.

Crypton leather & vinyl cleaner and restorer (part #7082) can be used to remove the dye.

Cleaning Instruction: W-clean fabrics with water-based cleaning agents or water-based foam.

Cold Crack: Product cold crack is equal or greater than -28 degrees celsius (-18 fahrenheit).

Content: 100% Polyvinyl chloride (PVC)

Features: Oil resistant, sulfide & stain resistant finish.

Fire Retardancy: BIFMA class 1, California bulletin 117-Section E

Ultraviolet: Product has ultraviolet resistant properties of an unknown number of hours, or less than 300 hours.

Weight: 22.33 oz/sq. yd, 33.50 oz/linear yd.

Rogue II



RU900 Flint



RU910 Turquoise Blue



RU920 Taupe



RU930 Ninja



RU940 Eucalyptus



RU950 Blue Mist



RU960 Rose

Specifications

Width: 54"

Abrasion: Exceeds 100,000 double rubs

Backing Content: 100% polyester

Cautions: White vinyl: dye transfer from clothing (especially blue jeans) onto white vinyl. This transfer is due to the wide range of dyes now being used in clothing coming from different countries. This is not a defect.

Crypton leather & vinyl cleaner and restorer (part #7082) can be used to remove the dye.

Cleaning Instruction: W-clean fabrics with water-based cleaning agents or water-based foam.

Cold Crack: Product cold crack is equal or greater than -28 degrees celsius (-18 fahrenheit).

Content: 100% Polyvinyl chloride (PVC)

Features: Oil resistant, sulfide & stain resistant finish.

Fire Retardancy: BIFMA class 1, California bulletin 117-Section E

Ultraviolet: Product has ultraviolet resistant properties of an unknown number of hours, or less than 300 hours.

Weight: 22.33 oz/sq. yd, 33.50 oz/linear yd.

Apex

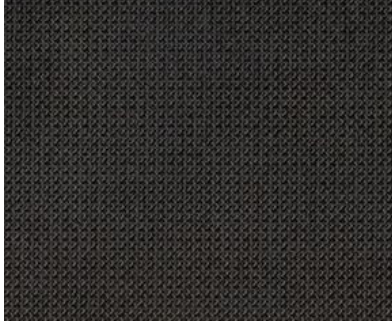

2548 Raven



2550 Cherry Wood



2551 Steel Silver

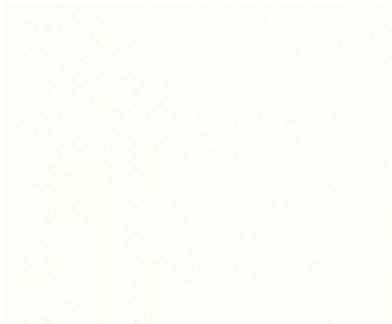

2554 Brilliant White



2555 Midnight

Specifications

Width: 54"

Abrasion: Exceeds 100,000 double rubs

Backing Content: 100% polyester

Cautions: Remove most stains with a soft cloth or sponge, mild soap and water. If stubborn stains remain, use a soft brush. Rinse thoroughly with clean water and wipe dry. **DO NOT USE POWERED ABRASIVES OR STEEL WOOL.** Product of this nature will always result in additional damage. White vinyl: Dye transfer from clothing (especially blue jeans) onto white vinyl. This transfer is due to the wide range of dyes now being used in clothing coming from different countries. This is not a defect to the vinyl. Crypton leather & vinyl cleaner (part # 7082) can be used to remove the dye.

Cleaning Instruction: Mild soap and water. Cleanable with Virox 5.

Cold Crack: Product cold crack is equal or greater than -23 degrees celsius (-10 fahrenheit)

Content: 100% polyvinyl chloride (PVC)

Features: Multi purpose vinyl with UV stabilized pigments and antifungal protection. Stitching strength (DIN 54301 lbs): warp 17, fill 14. Adhesion (CFFA 3/ASTM D751 lbs/in): warp 8, fill 8. Also passes FR standard BIFMA class 2. Crocking (CFFA 7/fed std 191a m 5551): wet and dry - excellent antifungal, antibacterial, antistain protection urethane topcoat.

Fire Protection: BIFMA class 1. California bulletin 117-section e. UFAC class 1, UFAC class 2.

Mildew: Product is mildew resistant.

Protective finish: Permablok 3

Tear Strength: Passes ASTM D5733 - Warp 13 lbs, fill 17 lbs.

Tensile Strength: Passes ASTM D751 - Warp 150 lbs, fill 110 lbs.

Thickness: Product is 4.5mm thick.

Ultraviolet: Product is rated ultraviolet resistant equal to or greater than 1000 hours.

Weight: 29 oz/sq. yd.

Poetry



67 Beige

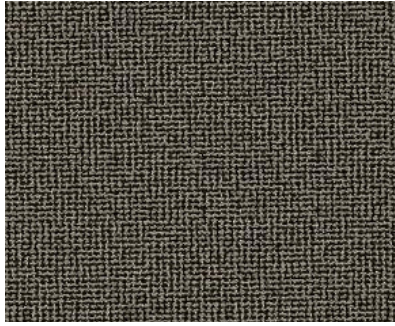

94 Smoke



308 Marina



1006 Merlot



8003 Gypsum

Specifications

Width: 54"

Abrasion: Exceeds 100,000 double rubs

Cautions: Do not use solvent based cleaners, dry cleaning products or bleach. They will eventually harm the fabric. If bleach must be used, a solution of 3 parts water to 1 part bleach is recommended.

Cleaning Instructions: Crypton upholstery cleaners w-clean fabrics with water-based cleaning agents or water-based foam.

Construction: Crypton jacquards

Content: 100% polyester

Fire Retardancy: California bulletin 117-section e, NFPA 260 Class 1, UFAC class 1.

Hydrostatic Resistance: AATCC 127 (Suter) - average 1000 mm.

Mildew: Product is mildew resistant.

Protective Finish: Crypton

Seam Slippage: Passes seam slippage ASTM-D4034 F83 x W83 lbf

Tear Strength: Passes ASTM D2261 - warp 17 lbs, fill 17 lbs.

Tensile Strength: Passes ASTM D5034 - warp 214 lbs, fill 184 lbs.

Weight: 12 oz/linear yd.

Stratosphere

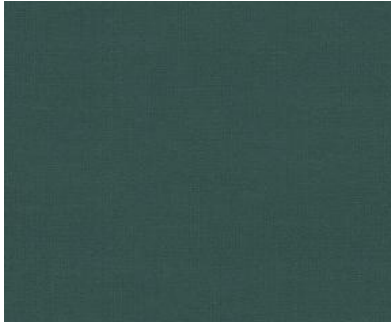

2401 Turquoise Metallic

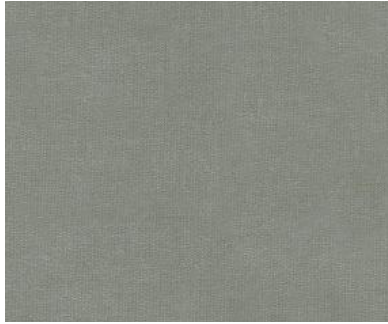

2402 Concrete Metallic

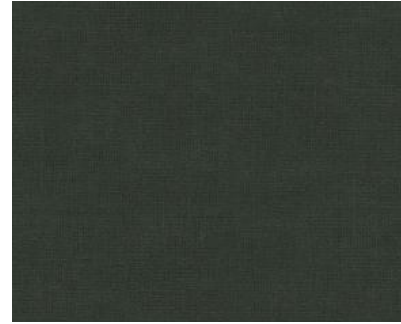

2403 Charcoal Metallic



2404 Ice Blue Metallic



2405 Mystic Blue Metallic



2406 Cobalt Metallic

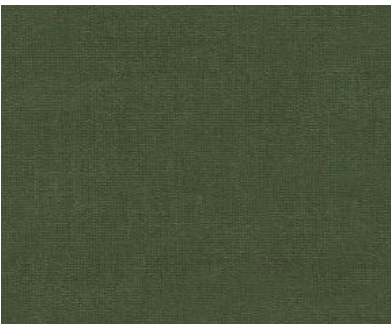

2407 Grass Metallic

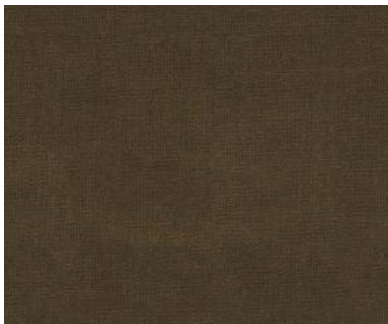

2408 Copper Metallic



2409 Pumpkin Metallic

Specifications

Width: 54"

Abrasion: Exceeds 100,000 double rubs

Backing Content: 100% polyester

Cautions: White vinyl: dye transfer from clothing (especially blue jeans) onto white vinyl. This transfer is due to the wide range of dyes now being used in clothing coming from different countries. This is not a defect.

Crypton leather & vinyl cleaner and restorer (part #7082) can be used to remove the dye.

Cleaning Instruction: Cleanable with Virox 5. W-clean fabrics with water-based cleaning agents or water-based foam.

Cold Crack: Product cold crack is equal or greater than -23 degrees celcius (-10 fahrenheit).

Content: 100% Polyvinyl chloride (PVC)

Features: Tear strength: fed stnd 191 M5138 warp 25 lbs, fill 30 lbs.

Fire Retardancy: California bulletin 117-section e, NFPA 260 class 1, UFAC class 1.

Mildew: Product is mildew resistant.

Tensile Strength: Passes ASTM D751 - warp 147 lbs, fill 144 lbs.

Ultraviolet: Product is rated ultraviolet resistant equal or greater than 1000 hours.

Weight: 18 oz/sq. yd, 27 oz/linear yd.

Stratosphere

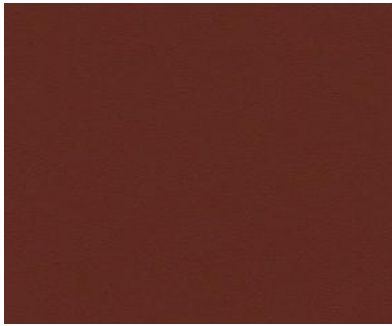

2410 Poppy Metallic

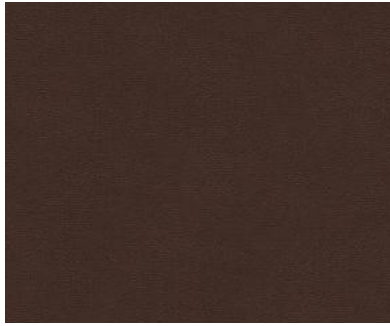

2411 Bordeaux Metallic

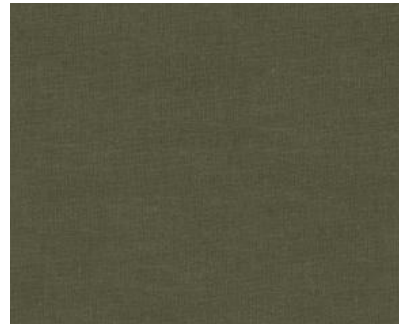

2412 Taupe Metallic

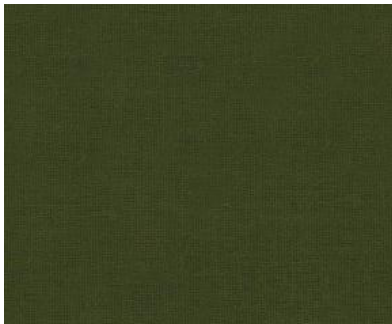

2413 Moss Metallic



2414 Bronze Metallic

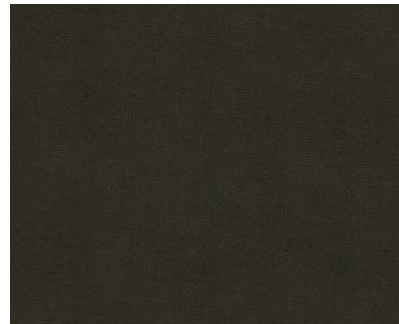

2415 Espresso Metallic

Specifications

Width: 54"

Abrasion: Exceeds 100,000 double rubs

Backing Content: 100% polyester

Cautions: White vinyl: dye transfer from clothing (especially blue jeans) onto white vinyl. This transfer is due to the wide range of dyes now being used in clothing coming from different countries. This is not a defect.

Crypton leather & vinyl cleaner and restorer (part #7082) can be used to remove the dye.

Cleaning Instruction: Cleanable with Virox 5. W-clean fabrics with water-based cleaning agents or water-based foam.

Cold Crack: Product cold crack is equal or greater than -23 degrees celcius (-10 fahrenheit).

Content: 100% Polyvinyl chloride (PVC)

Features: Tear strength: fed stnd 191 M5138 warp 25 lbs, fill 30 lbs.

Fire Retardancy: California bulletin 117-section e, NFPA 260 class 1, UFAC class 1.

Mildew: Product is mildew resistant.

Tensile Strength: Passes ASTM D751 - warp 147 lbs, fill 144 lbs.

Ultraviolet: Product is rated ultraviolet resistant equal or greater than 1000 hours.

Weight: 18 oz/sq. yd, 27 oz/linear yd.

Pollen



37 Lagoon

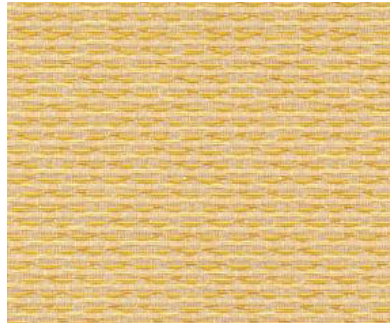

51 Yellow



61 Vanilla



87 Chestnut



205 Sprig



6009 Chinchilla

Specifications

Width: 54"

Abrasion: Exceeds 51,000 double rubs

Cleaning Instruction: Crypton upholstery cleaners. Cleanable with Virox 5. W-clean fabrics with water-based cleaning agents or water-based foam.

Content: 40% polyester, 60% cotton

Crocking: AATCC 8: wet class 3, dry class 4

Fire Retardancy: California bulletin 117-section e, UFAC class 1

Mildew: Product is mildew resistant.

Pilling: Passes ASTM D3511 - Class 5

Protective Finish: Crypton

Repeat: Length 1.3", width 1.3"

Seam Slippage: Passes seam slippage ASTM D4034. F42 x W54 lbs.

Tear Strength: Passes ASTM D2661 - Warp 22 lbs, fill 13 lbs.

Tensile Strength: Passes ASTM D5034 - Warp 203 lbs, fill 96 lbs.

Ultraviolet: Colorfastness to light AATCC16 class 4.

Weight: 10.40 oz/linear yd, 6.93 oz/sq. yd.

Reflect



37 Lagoon



51 Yellow



61 Vanilla

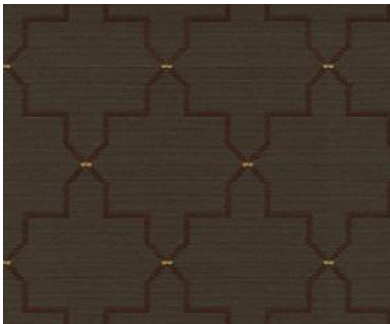

87 Chestnut



205 Sprig



1006 Rust



1009 Plum



6009 Chinchilla

Specifications

Width: 54"

Abrasion: Exceeds 51,000 double rubs

Cleaning Instruction: Crypton upholstery cleaners. Cleanable with Virox 5. W-clean fabrics with water-based cleaning agents or water-based foam.

Content: 47% polyester, 53% cotton

Crocking: AATCC 8: wet class 3, dry class 4

Fire Retardancy: California bulletin 117-section e, UFAC class 1

Mildew: Product is mildew resistant.

Pilling: Passes ASTM D3511 - class 5

Protective Finish: Crypton

Repeat: length - 2.5", width 2.9"

Seam Slippage: Passes ASTM D4034, f56 x w72 lbf

Tear Strength: Passes ASTM D2261 - warp 15 lbs, fill 21 lbs

Tensile Strength: Passes ASTM D5034 - warp 192 lbs, fill 78 lbs

Ultraviolet: Colorfastness to light AATCC16 class 4

Weight: 6.29 oz/sq. yd, 9.44 oz/linear yd

Glam



17 Auburn



44 Pumpkin



87 Chestnut



205 Sprig



305 Denim



6009 Chinchilla



9009 Black

Specifications

Width: 60"

Abrasion: Exceeds 50,000 double rubs

Cleaning Instruction: Crypton upholstery cleaners. Cleanable with Virox 5. W-clean fabrics with water-based cleaning agents or water-based foam.

Content: 6% recycled post consumer polyester, 11% recycled post industrial polyester, 42% cotton

Crocking: AATCC 8: wet class 3, dry class 4

Fire Retardancy: California bulletin 117-section e, UFAC class

Mildew: Product is mildew resistant

Pilling: Passes ASTM D3511 - class 5

Protective Finish: Crypton

Repeat: Length 13.1" width 7.5"

Seam Slippage: Passes seam slippage ASTM D4034, f95 x w90 lbf

Tear Strength: Passes ASTM D2261 - warp 16 lbs, fill 17 lbs

Tensile Strength: Passes ASTM D5034 - warp 223 lbs, fill 93 lbs

Ultraviolet: Lightfastness is 40 hours. Colorfastness to light AATCC16 class 4

Weight: 10.04 oz/linear yd, 6.02 oz/sq. yd.

Influence



19 Claret



37 Lagoon

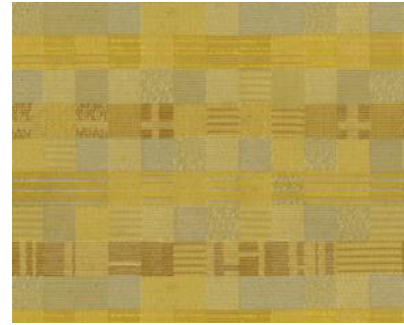

51 Yellow

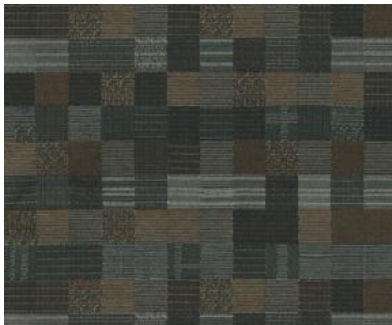

87 Chestnut



205 Sprig



305 Denim



905 Steel



6009 Chinchilla

Specifications

Width: 55.75"

Abrasion: Exceeds 50,000 double rubs

Cleaning Instruction: Crypton upholstery cleaners. Cleanable with Virox 5. W-clean fabrics with water-based cleaning agents or water-based foam.

Content: 9% recycled post consumer polyester, 10% recycled post industrial polyester, 10% cotton, 41% polyester

Crocking: AATCC8: wet class 3, dry class 4

Fire Retardancy: California bulleting 117-section e, UFAC class 1

Mildew: Product is mildew resistant.

Pilling: Passes ASTM D3511 - class 5

Protective Finish: Crypton

Repeat: Length 2.1", width 2.9"

Seam Slippage: Passes seam slippage ASTM D4034, f92 x w71 lbf

Tear Strength: Passes ASTM D2261 - warp 24 lbs, fill 17 lbs

Tensile Strength: Passes ASTM D5034 - warp 219 lbs, fill 101 lbs

Ultraviolet: Lightfastness is 40 hours. Colorfastness to light AATCC16 class 4.

Weight: 10.01 oz/linear yd, 6.46 oz/sq. yd.

Movement



17 Auburn



37 Lagoon



44 Pumpkin



51 Yellow



308 Navy



608 Linen



908 Charcoal



6009 Chinchilla



9009 Black

Specifications

Width: 54.5"

Abrasion: Exceeds 100,000 double rubs

Cleaning Instruction: Crypton upholstery cleaners. Cleanable with Virox 5. W-clean fabrics with water-based cleaning agents or w-based foam.

Content: 40% polyester, 60% cotton

Crocking: AATCC8 wet class 3, dry class 4

Fire Retardancy: California bulletin 117-section e, UFAC class 1

Mildew: Product is mildew resistant.

Pilling: Passes ASTM D3511 - class 5

Protective Finish: Crypton

Repeat: Length 8.0", width 5.9"

Seam Slippage: Passes seam slippage ASTM-D4034, f88 x w77 lbf

Tear Strength: Passes ASTM D2261 warp 11 lbs, fill 24 lbs

Tensile Strength: Passes ASTM D5034 warp 241 lbs, fill 97 lbs

Ultraviolet: Lightfastness is 40 hours. Colorfastness to light AATCC16 class 4.

Weight: 10.43 oz/linear yd, 6.95 oz/sq. yd.

Stimulate



17 Auburn



37 Lagoon



44 Pumpkin



51 Yellow



81 Sandalwood



205 Sprig



305 Denim



608 Linen



908 Charcoal

Specifications

Width: 56"

Abrasion: Exceeds 50,000 double rubs

Cleaning Instruction: Crypton upholstery cleaners. Cleanable with Virox 5. W-clean fabrics with water-based cleaning agents or w-based foam.

Content: 12% recycled post industrial polyester, 20% recycled post consumer polyester, 23% cotton, 45% polyester

Crocking: AATCC8 wet class 3, dry class 4

Fire Retardancy: California bulletin 117-section e, UFAC class 1

Mildew: Product is mildew resistant.

Pilling: Passes ASTM D3511 - class 5

Protective Finish: Crypton

Repeat: Length 4.0", width 2.9"

Seam Slippage: Passes seam slippage ASTM-D4034, f54 x w70 lbf

Tear Strength: Passes ASTM D2261 warp 25 lbs, fill 17 lbs

Tensile Strength: Passes ASTM D5034 warp 235 lbs, fill 123 lbs

Ultraviolet: Lightfastness is 40 hours. Colorfastness to light AATCC16 class 4.

Weight: 9.12 oz/linear yd, 5.86 oz/sq. yd.

Stimulate



6009 Chinchilla



9009 Black

Specifications

Width: 56"

Abrasion: Exceeds 50,000 double rubs

Cleaning Instruction: Crypton upholstery cleaners. Cleanable with Virox 5. W-clean fabrics with water-based cleaning agents or w-based foam.

Content: 12% recycled post industrial polyester, 20% recycled post consumer polyester, 23% cotton, 45% polyester

Crocking: AATCC8 wet class 3, dry class 4

Fire Retardancy: California bulletin 117-section e, UFAC class 1

Mildew: Product is mildew resistant.

Pilling: Passes ASTM D3511 - class 5

Protective Finish: Crypton

Repeat: Length 4.0", width 2.9"

Seam Slippage: Passes seam slippage ASTM-D4034, f54 x w70 lbf

Tear Strength: Passes ASTM D2261 warp 25 lbs, fill 17 lbs

Tensile Strength: Passes ASTM D5034 warp 235 lbs, fill 123 lbs

Ultraviolet: Lightfastness is 40 hours. Colorfastness to light AATCC16 class 4.

Weight: 9.12 oz/linear yd, 5.86 oz/sq. yd.

Wicker



17 Auburn



37 Lagoon



44 Pumpkin

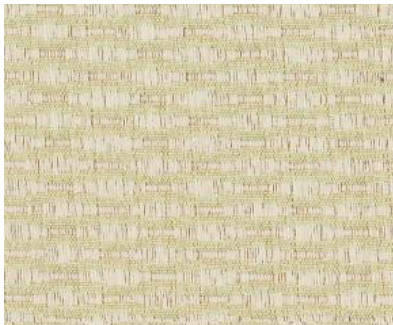

61 Vanilla



87 Chestnut



91 Light Grey

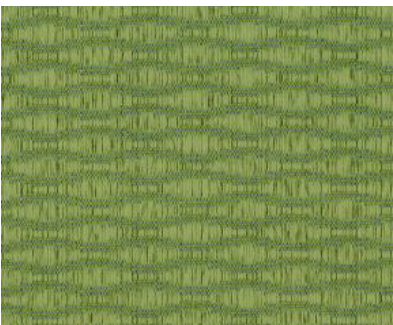

205 Sprig



305 Empire



502 Cornsilk

Specifications

Width: 54"

Abrasion: Exceeds 54,000 double rubs

Cleaning Instruction: Crypton upholstery cleaners. Cleanable with Virox 5. W-clean fabrics with water-based cleaning agents or w-based foam.

Content: 16% recycled post consumer polyester, 17% recycled post industrial polyester, 67% polyester

Crocking: AATCC8 wet class 3, dry class 4

Elongation: ASTM D5304 warp 3.2%, fill 2.7%

Fire Retardancy: California bulletin 117-section e, UFAC class 1

Mildew: Product is mildew resistant.

Pilling: Passes ASTM D3511 - class 5

Protective Finish: Crypton

Repeat: Length .8", width .4"

Seam Slippage: Passes seam slippage ASTM-D4034, f97 x w45 lbf

Tear Strength: Passes ASTM D2261 warp 39 lbs, fill 60 lbs

Tensile Strength: Passes ASTM D5034 warp 222 lbs, fill 261 lbs

Ultraviolet: Colorfastness to light AATCC16 class 4.

Weight: 10.16 oz/linear yd, 6.53 oz/sq. yd.

Wicker

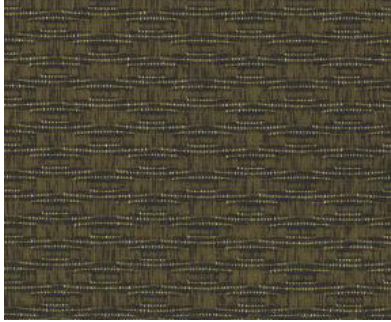

6009 Chinchilla

Specifications

Width: 54"

Abrasion: Exceeds 54,000 double rubs

Cleaning Instruction: Crypton upholstery cleaners. Cleanable with Virox 5. W-clean fabrics with water-based cleaning agents or w-based foam.

Content: 16% recycled post consumer polyester, 17% recycled post industrial polyester, 67% polyester

Crocking: AATCC8 wet class 3, dry class 4

Elongation: ASTM D5304 warp 3.2%, fill 2.7%

Fire Retardancy: California bulletin 117-section e, UFAC class 1

Mildew: Product is mildew resistant.

Pilling: Passes ASTM D3511 - class 5

Protective Finish: Crypton

Repeat: Length .8", width .4"

Seam Slippage: Passes seam slippage ASTM-D4034, f97 x w45 lbf

Tear Strength: Passes ASTM D2261 warp 39 lbs, fill 60 lbs

Tensile Strength: Passes ASTM D5034 warp 222 lbs, fill 261 lbs

Ultraviolet: Colorfastness to light AATCC16 class 4.

Weight: 10.16 oz/linear yd, 6.53 oz/sq. yd.

Nauga Soft

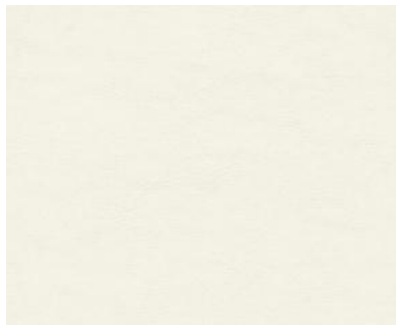

34 Soft White



35 Fawn



36 Cabernet

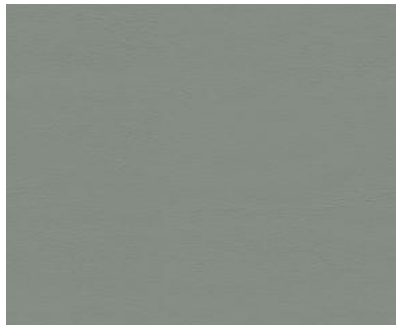

37 Feather



38 Harness



39 Laurel

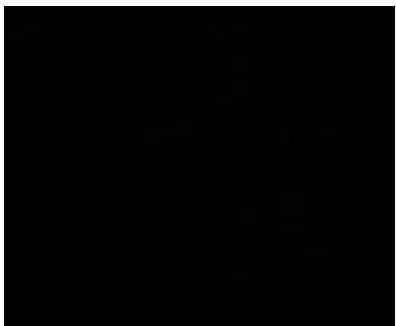

40 Black Satin

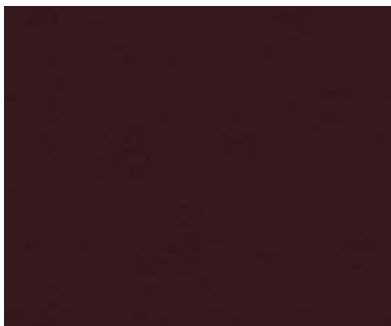

41 Mulberry



42 Rose Blush

Specifications

Width: 54"

Abrasion: Exceeds 1,000,000 double rubs

Cautions: White vinyl: dye transfer from clothing (especially blue jeans) onto white vinyl. This transfer is due to the wide range of dyes now being used in clothing coming from different countries. This is not a defect.

Crypton leather & vinyl cleaner and restorer (part #7082) can be used to remove the dye.

Cleaning Instruction: W-clean fabrics with water-based cleaning agents or w-based foam.

Content: 100% polyvinyl chloride (PVC)

Cold Crack: Product cold crack is equal or greater than -28 degrees celsius (-18 fahrenheit).

Features: Contains an agent to protect it against fungal microorganisms. Pink stain test - ASTM E-1428 oil resistant, sulfide and stain resistant finish, anti-bacterial.

Fire Retardancy: California bulletin 117-section e

Mildew: Product is mildew resistant.

Pilling: Passes ASTM D3511 - class 5

Protective Finish: Beauty Guard

Tear Strength: Passes CFFA-16C warp 15 lbs, fill 15 lbs

Tensile Strength: Passes CFFA-17 warp 70 lbs, fill 60 lbs

Ultraviolet: Product has ultraviolet resistant properties of an unknown number of hours, or less than 300 hours.

Weight: 28.20 oz/linear yd, 18.80 oz/sq. yd.

Nauga Soft

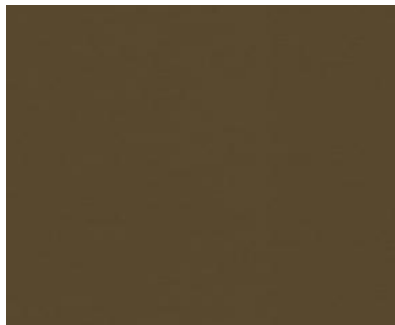

43 Velvet Brown

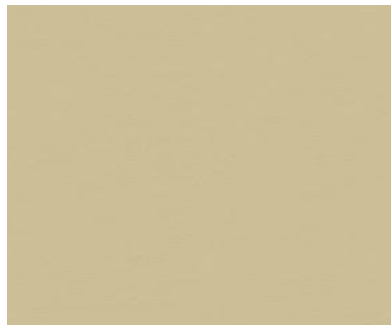

44 Cream

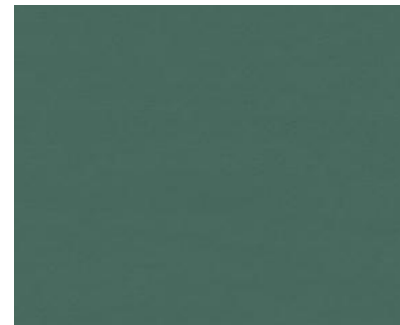

45 Mint Leaf



46 Blue Fog

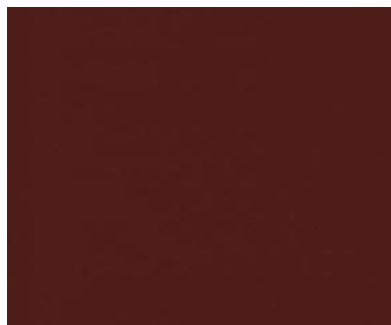

47 Tapestry Red

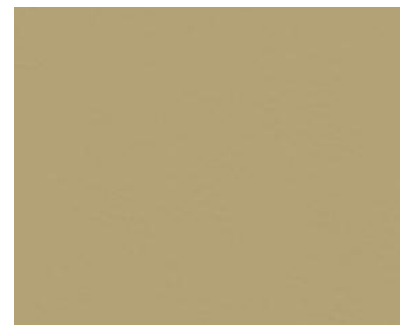

48 Doeskin



49 Deep Sea



50 Lake Louise

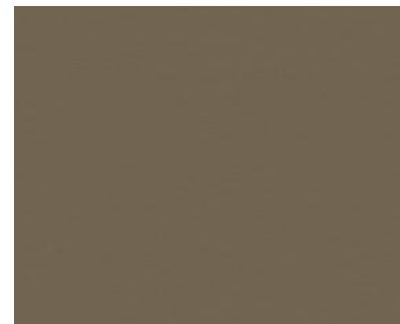

51 Cocoa

Specifications

Width: 54"

Abrasion: Exceeds 1,000,000 double rubs

Cautions: White vinyl: dye transfer from clothing (especially blue jeans) onto white vinyl. This transfer is due to the wide range of dyes now being used in clothing coming from different countries. This is not a defect.

Crypton leather & vinyl cleaner and restorer (part #7082) can be used to remove the dye.

Cleaning Instruction: W-clean fabrics with water-based cleaning agents or w-based foam.

Content: 100% polyvinyl chloride (PVC)

Cold Crack: Product cold crack is equal or greater than -28 degrees celsius (-18 fahrenheit).

Features: Contains an agent to protect it against fungal microorganisms. Pink stain test - ASTM E-1428 oil resistant, sulfide and stain resistant finish, anti-bacterial.

Fire Retardancy: California bulletin 117-section e

Mildew: Product is mildew resistant.

Pilling: Passes ASTM D3511 - class 5

Protective Finish: Beauty Guard

Tear Strength: Passes CFFA-16C warp 15 lbs, fill 15 lbs

Tensile Strength: Passes CFFA-17 warp 70 lbs, fill 60 lbs

Ultraviolet: Product has ultraviolet resistant properties of an unknown number of hours, or less than 300 hours.

Weight: 28.20 oz/linear yd, 18.80 oz/sq. yd.

Nauga Soft



52 Saddle



53 Ivy



54 Mallard Blue

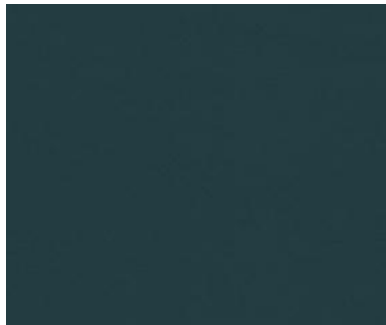

55 Deep Sapphire

Specifications

Width: 54"

Abrasion: Exceeds 1,000,000 double rubs

Cautions: White vinyl: dye transfer from clothing (especially blue jeans) onto white vinyl. This transfer is due to the wide range of dyes now being used in clothing coming from different countries. This is not a defect.

Crypton leather & vinyl cleaner and restorer (part #7082) can be used to remove the dye.

Cleaning Instruction: W-clean fabrics with water-based cleaning agents or w-based foam.

Content: 100% polyvinyl chloride (PVC)

Cold Crack: Product cold crack is equal or greater than -28 degrees celsius (-18 fahrenheit).

Features: Contains an agent to protect it against fungal microorganisms. Pink stain test - ASTM E-1428 oil resistant, sulfide and stain resistant finish, anti-bacterial.

Fire Retardancy: California bulletin 117-section e

Mildew: Product is mildew resistant.

Pilling: Passes ASTM D3511 - class 5

Protective Finish: Beauty Guard

Tear Strength: Passes CFFA-16C warp 15 lbs, fill 15 lbs

Tensile Strength: Passes CFFA-17 warp 70 lbs, fill 60 lbs

Ultraviolet: Product has ultraviolet resistant properties of an unknown number of hours, or less than 300 hours.

Weight: 28.20 oz/linear yd, 18.80 oz/sq. yd.

Reflex

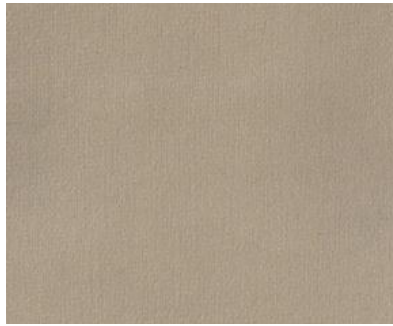

7851 Pearl

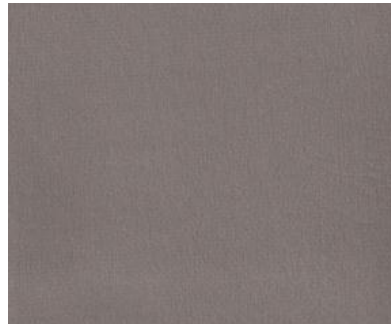

7852 Mineral



7853 Voltron



7854 Pro Tour Red



7855 Blade

Specifications

Width: 54"

Abrasion: Exceeds 100,000 double rubs

Backing Content: 100% polyester

Cleaning Instructions: Cleanable with Virox 5. See features/cautions.

Cold Crack: Product cold crack is equal to or greater than -28 degrees celsius (-18 fahrenheit).

Construction: Vinyl

Crocking: AATCC 8 dry class*

Features: Silverguard, permablok anti-bacterial, stain resistant, no heavy metals, scratch resistant, formaldehyde free, anti static finish.

Cleaning Instructions: for eye shadow/mascara/grease/black felt pen/crayon/chocolate/suntan lotion/hair & body oils - remove excess with a damp cloth. Clean with a 1:1 mixture of Ivory liquid soap and water, then rinse with clean water and dry. For red lipstick - use a straight application of concentrated cleaners such as Formula 409 or Fantastik spray cleaner. Wipe with a clean cloth, rinse with water and dry. Cleaning instructions for blood/urine/feces/oil based paints/tar/asphalt - use a 1:1 mixture of ammonia, or a 1:4 mix of bleach and water. Rinse with clean water and dry. For all other tough stains - with a soft cotton cloth saturated with the cleaning material, rub in circles. Use either naphtha (lighter fluid), or a 1:1 mixture of isopropyl alcohol and water, and if persists use straight alcohol. Rinse thoroughly with clean water and pat dry.

Fire Retardancy: Boston fire code 9-x11, California bulletin 117-section e, UFAC class 1

Mildew: Product is mildew resistant.

Ultraviolet: Product is rated ultraviolet resistant equal to or greater than 1000 hours.

Weight: 20.00 oz/sq. yd, 30.00 oz/yd.

Silvertex

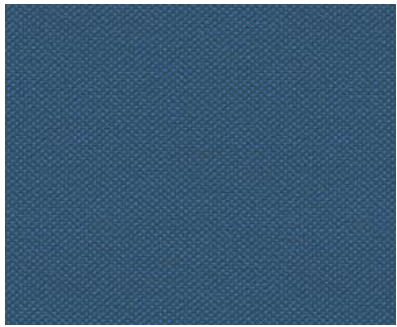

8801 Marine Blue

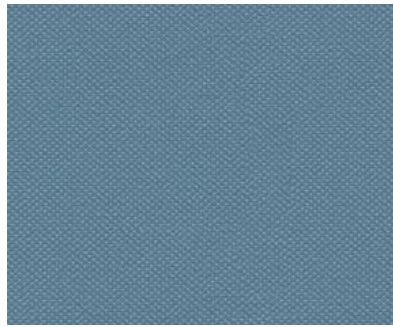

8802 Lagoon

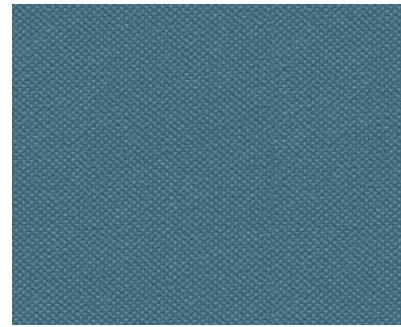

8803 Turquoise

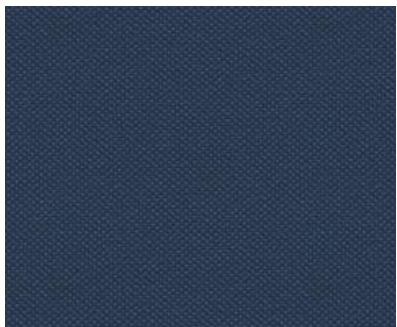

8804 Sapphire

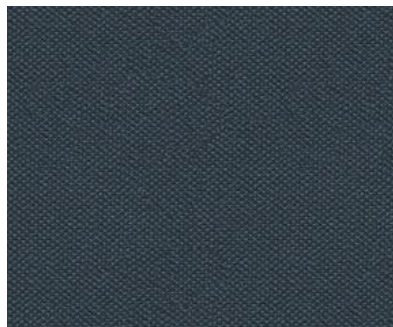

8805 Jet

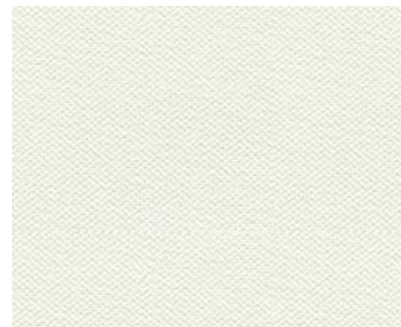

8806 Ice



8807 Cream



8808 Champagne



8809 Taupe

Specifications

Width: 54"

Abrasion: Exceeds 100,000 double rubs

Backing Content: 100% polyester

Cleaning Instruction: Cleanable with Virox 5.

Cold Crack: Product cold crack is equal to or greater than -23 degrees celsius (-10 fahrenheit).

Content: 100% polyvinyl chloride (PVC)

Elongation: CFFA 17/ASTM D-751 warp 67%, weft 164%

Fire Retardancy: California bulletin 117-section e, UFAC class 1

Mildew: Product is mildew resistant.

Protective Finish: Anti-static Permablok 3 Silverguard provides a natural germ-fighting defense to help safeguard against odor and stain causing bacteria. Sain and soil resistant finish.

Tear Strength: Passes ASTM D5733 warp 20 lbs, fill 20 lbs. Passes CFFA-16C warp 20 lbs, fill 20 lbs.

Tensile Strength: Passes ASTN D751 warp 123 lbs, fill 87 lbs. Passes CFFA-17 warp 123 lbs, fill 87 lbs.

Ultraviolet: Product is rated ultraviolet resistant equal or greater than 1000 hours.

Weight: 30.00 oz/linear yd.

Silvertex

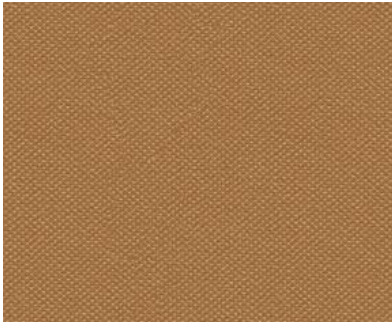

8810 Chestnut

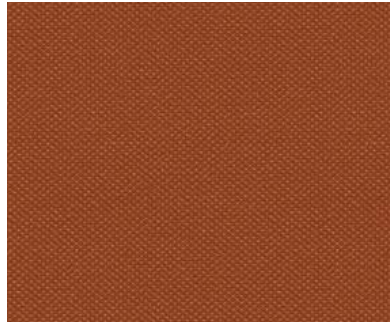

8811 Mandarin

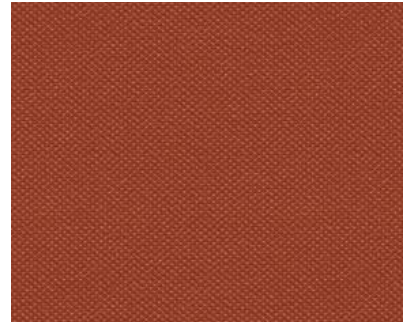

8812 Sunkist



8813 Luggage



8814 Umber



8815 Borscht



8816 Raspberry



8817 Blackberry



8818 Sage

Specifications

Width: 54"

Abrasion: Exceeds 100,000 double rubs

Backing Content: 100% polyester

Cleaning Instruction: Cleanable with Virox 5.

Cold Crack: Product cold crack is equal to or greater than -23 degrees celsius (-10 fahrenheit).

Content: 100% polyvinyl chloride (PVC)

Elongation: CFFA 17/ASTM D-751 warp 67%, weft 164%

Fire Retardancy: California bulletin 117-section e, UFAC class 1

Mildew: Product is mildew resistant.

Protective Finish: Anti-static Permablok 3 Silverguard provides a natural germ-fighting defense to help safeguard against odor and stain causing bacteria. Sain and soil resistant finish.

Tear Strength: Passes ASTM D5733 warp 20 lbs, fill 20 lbs. Passes CFFA-16C warp 20 lbs, fill 20 lbs.

Tensile Strength: Passes ASTN D751 warp 123 lbs, fill 87 lbs. Passes CFFA-17 warp 123 lbs, fill 87 lbs.

Ultraviolet: Product is rated ultraviolet resistant equal or greater than 1000 hours.

Weight: 30.00 oz/linear yd.

Silvertex

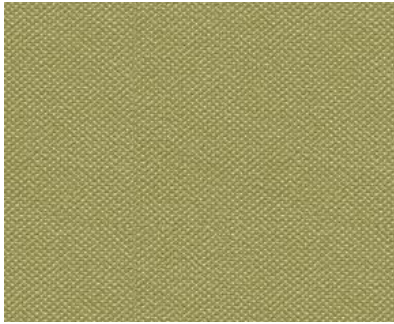

8819 Celery

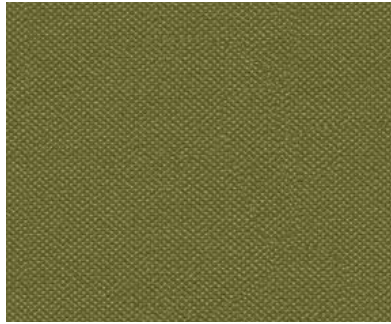

8820 Basil

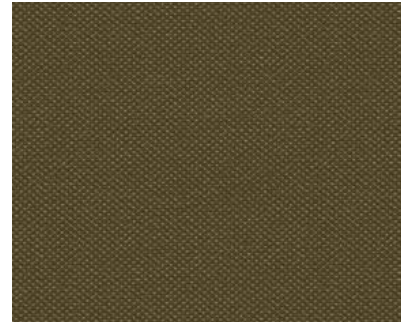

8821 Bottle

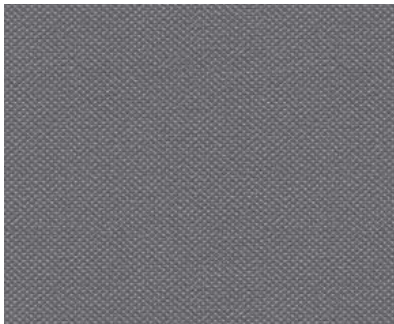

8822 Storm

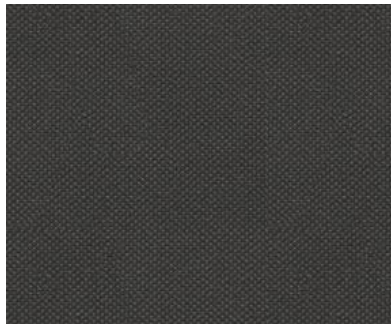

8823 Carbon



8824 Meteor

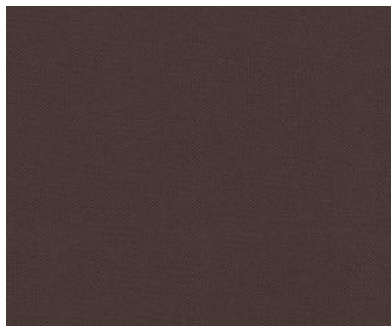

8825 Mocha

Specifications

Width: 54"

Abrasion: Exceeds 100,000 double rubs

Backing Content: 100% polyester

Cleaning Instruction: Cleanable with Virox 5.

Cold Crack: Product cold crack is equal to or greater than -23 degrees celsius (-10 fahrenheit).

Content: 100% polyvinyl chloride (PVC)

Elongation: CFFA 17/ASTM D-751 warp 67%, weft 164%

Fire Retardancy: California bulletin 117-section e, UFAC class 1

Mildew: Product is mildew resistant.

Protective Finish: Anti-static Permablok 3 Silverguard provides a natural germ-fighting defense to help safeguard against odor and stain causing bacteria. Sain and soil resistant finish.

Tear Strength: Passes ASTM D5733 warp 20 lbs, fill 20 lbs. Passes CFFA-16C warp 20 lbs, fill 20 lbs.

Tensile Strength: Passes ASTN D751 warp 123 lbs, fill 87 lbs. Passes CFFA-17 warp 123 lbs, fill 87 lbs.

Ultraviolet: Product is rated ultraviolet resistant equal or greater than 1000 hours.

Weight: 30.00 oz/linear yd.

Chamea II



01 Graphite Grey

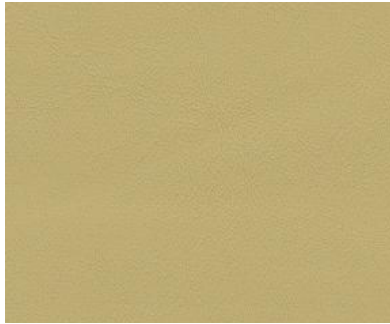

02 Stardust



03 Red



04 Beach



05 Sunlight



06 Stone



07 Butter



08 Baja Brown



09 Water

Specifications

Width: 54"

Abrasion: Exceeds 250,000 double rubs

Backing Content: 100% polyester

Cautions: White vinyl: dye transfer from clothing (especially blue jeans) onto white vinyl. This transfer is due to the wide range of dyes now being used in clothing coming from different countries. This is not a defect.

Crypton leather & vinyl cleaner and restorer (part #7082) can be used to remove the dye.

Cleaning Instruction: W-clean fabrics with water-based cleaning agents or water-based foam.

Cold Crack: Product cold crack is equal to or greater than -28 degrees celsius (-18 fahrenheit).

Content: 100% Polyvinyl chloride (PVC)

Features: Elongation: CFFA-15 warp 10% fill 100%. Seam strength: CFFA-17 warp 50 lbs, fill 25 lbs. Coating/fabric bond CFFA-3a 3.5 lb/in. Blocking: CFFA-7 scale rating no. 3 maximum. Accelerated weathering resistance SAEJ1885, no more than slight discoloration, change in gloss or surface degradation after exposure to 225.6 kj/m². Ultraviolet stable pigment passes ASTM E1428 pink stain test, oil resistant, anti-fungal, anti-bacterial, static dissipative, sulfide and stain resistant. Finish disinfectability, can be disinfected using a diluted 1:10 bleach water solution.

Fire Retardancy: BIFMA class 1. California bulletin 117-section e, UFAC class 1.

Mildew: Product is mildew resistant.

Protective Finish: Beauty Guard

Tear Strength: Passes CFFA-16C warp 12 lbs, fill 12 lbs

Tensile Strength: Passes CFFA-17 warp 85 lbs, fill 60 lbs

Weight: 17.40 oz/sq. yd, 26.00 oz/ linear yd.

Chamea II



10 Palm



11 Olive



12 Sand



13 Chaps



14 Mahogany



15 Buff



16 Spruce



17 Navy

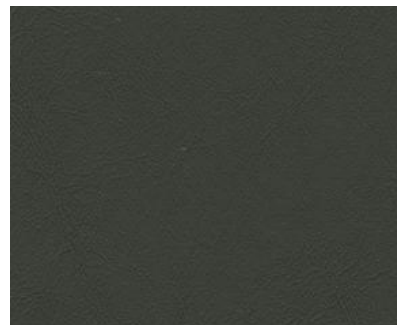

18 Black

Specifications

Width: 54"

Abrasion: Exceeds 250,000 double rubs

Backing Content: 100% polyester

Cautions: White vinyl: dye transfer from clothing (especially blue jeans) onto white vinyl. This transfer is due to the wide range of dyes now being used in clothing coming from different countries. This is not a defect.

Crypton leather & vinyl cleaner and restorer (part #7082) can be used to remove the dye.

Cleaning Instruction: W-clean fabrics with water-based cleaning agents or water-based foam.

Cold Crack: Product cold crack is equal to or greater than -28 degrees celsius (-18 fahrenheit).

Content: 100% Polyvinyl chloride (PVC)

Features: Elongation: CFFA-15 warp 10% fill 100%. Seam strength: CFFA-17 warp 50 lbs, fill 25 lbs. Coating/fabric bond CFFA-3a 3.5 lb/in. Blocking: CFFA-7 scale rating no. 3 maximum. Accelerated weathering resistance SAEJ1885, no more than slight discoloration, change in gloss or surface degradation after exposure to 225.6 kj/m². Ultraviolet stable pigment passes ASTM E1428 pink stain test, oil resistant, anti-fungal, anti-bacterial, static dissipative, sulfide and stain resistant. Finish disinfectability, can be disinfected using a diluted 1:10 bleach water solution.

Fire Retardancy: BIFMA class 1. California bulletin 117-section e, UFAC class 1.

Mildew: Product is mildew resistant.

Protective Finish: Beauty Guard

Tear Strength: Passes CFFA-16C warp 12 lbs, fill 12 lbs

Tensile Strength: Passes CFFA-17 warp 85 lbs, fill 60 lbs

Weight: 17.40 oz/sq. yd, 26.00 oz/ linear yd.

Chamea II



19 Antelope



20 Soft White

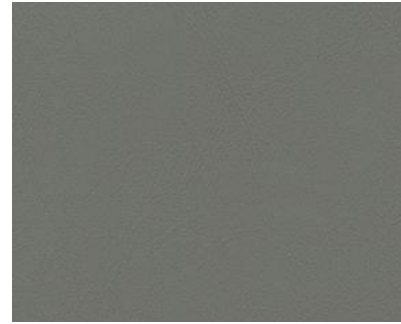

21 Dk Pewter

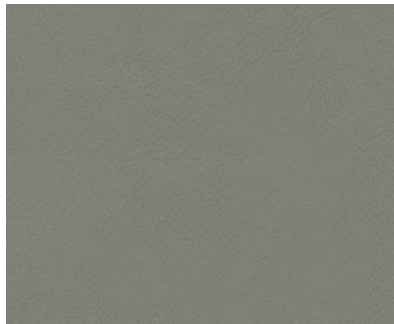

22 Lt Grey



23 Amber



24 Eden



25 First Light



26 Honesty

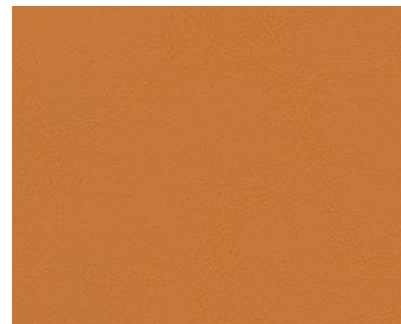

27 Marmalade

Specifications

Width: 54"

Abrasion: Exceeds 250,000 double rubs

Backing Content: 100% polyester

Cautions: White vinyl: dye transfer from clothing (especially blue jeans) onto white vinyl. This transfer is due to the wide range of dyes now being used in clothing coming from different countries. This is not a defect.

Crypton leather & vinyl cleaner and restorer (part #7082) can be used to remove the dye.

Cleaning Instruction: W-clean fabrics with water-based cleaning agents or water-based foam.

Cold Crack: Product cold crack is equal to or greater than -28 degrees celsius (-18 fahrenheit).

Content: 100% Polyvinyl chloride (PVC)

Features: Elongation: CFFA-15 warp 10% fill 100%. Seam strength: CFFA-17 warp 50 lbs, fill 25 lbs. Coating/fabric bond CFFA-3a 3.5 lb/in. Blocking: CFFA-7 scale rating no. 3 maximum. Accelerated weathering resistance SAEJ1885, no more than slight discoloration, change in gloss or surface degradation after exposure to 225.6 kj/m². Ultraviolet stable pigment passes ASTM E1428 pink stain test, oil resistant, anti-fungal, anti-bacterial, static dissipative, sulfide and stain resistant. Finish disinfectability, can be disinfected using a diluted 1:10 bleach water solution.

Fire Retardancy: BIFMA class 1. California bulletin 117-section e, UFAC class 1.

Mildew: Product is mildew resistant.

Protective Finish: Beauty Guard

Tear Strength: Passes CFFA-16C warp 12 lbs, fill 12 lbs

Tensile Strength: Passes CFFA-17 warp 85 lbs, fill 60 lbs

Weight: 17.40 oz/sq. yd, 26.00 oz/ linear yd.

Chamea II



28 Melon

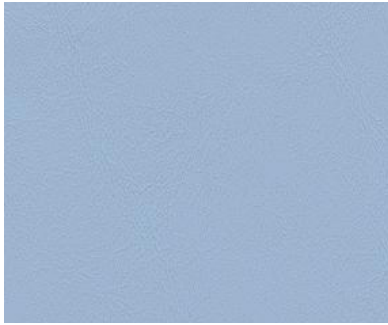

29 Ocean



30 Cyprus



31 Rosa



32 Sea Glass



33 Wood Violet

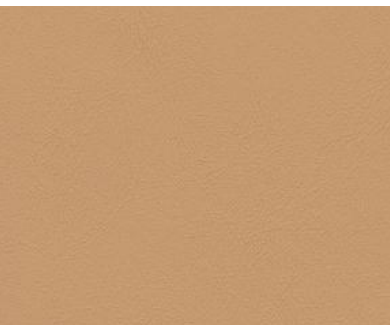

34 Spice



35 Valley

Specifications

Width: 54"

Abrasion: Exceeds 250,000 double rubs

Backing Content: 100% polyester

Cautions: White vinyl: dye transfer from clothing (especially blue jeans) onto white vinyl. This transfer is due to the wide range of dyes now being used in clothing coming from different countries. This is not a defect.

Crypton leather & vinyl cleaner and restorer (part #7082) can be used to remove the dye.

Cleaning Instruction: W-clean fabrics with water-based cleaning agents or water-based foam.

Cold Crack: Product cold crack is equal to or greater than -28 degrees celsius (-18 fahrenheit).

Content: 100% Polyvinyl chloride (PVC)

Features: Elongation: CFFA-15 warp 10% fill 100%. Seam strength: CFFA-17 warp 50 lbs, fill 25 lbs. Coating/fabric bond CFFA-3a 3.5 lb/in.

Blocking: CFFA-7 scale rating no. 3 maximum. Accelerated weathering resistance SAEJ1885, no more than slight discoloration, change in gloss or surface degradation after exposure to 225.6 kj/m². Ultraviolet stable pigment passes ASTM E1428 pink stain test, oil resistant, anti-fungal, anti-bacterial, static dissipative, sulfide and stain resistant. Finish disinfectability, can be disinfected using a diluted 1:10 bleach water solution.

Fire Retardancy: BIFMA class 1. California bulletin 117-section e, UFAC class 1.

Mildew: Product is mildew resistant.

Protective Finish: Beauty Guard

Tear Strength: Passes CFFA-16C warp 12 lbs, fill 12 lbs

Tensile Strength: Passes CFFA-17 warp 85 lbs, fill 60 lbs

Weight: 17.40 oz/sq. yd, 26.00 oz/ linear yd.

Premier



11 Brick



14 Rust



17 Garnet



21 Meadow

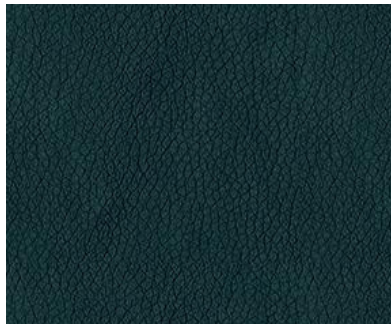

24 Deep Teal



37 Lagoon

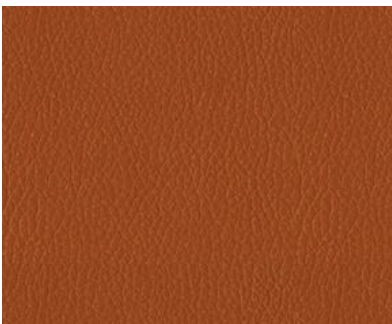

44 Pumpkin Spice



54 Citron

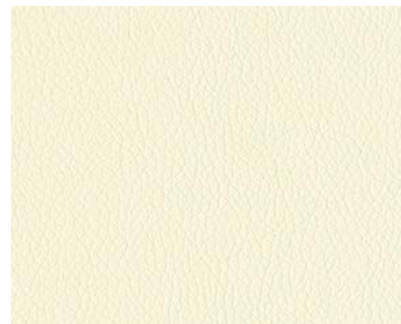

61 Vanilla

Specifications

Width: 54"

Abrasion: Exceeds 500,000 double rubs

Backing Content: 15% cotton, 85% polyester

Cleaning Instruction: Mild soap and water. Dry immediately with a soft, dry cloth.

Cold Crack: Product cold crack is equal to or greater than -30 degrees celsius (-22 fahrenheit).

Content: 100% Polyurethane (PU)

Crocking: AATCC 8 dry class 5, wet class 5

Elongation: ASTM D751 warp 14.3%, fill 25.7%

Features: Passes ASTM G21-15 grade 1 wipe with a soft cloth, with cold water and a mild soap. Dry immediately. Hydrolysis pass 7 weeks (equal 7 years). Phthalates free, pvc free. Cleanable with Virox 5, PCS sodium hypochlorite disinfectant and Triad III if cleaning directions are followed and product is wiped completely dry after cleaning. Adhesion of coating ASTM D751 section 45-48 warp = 11.2/lb in and weft = 6.04 lb/in.

REACH compliant, prop 65 compliant. Stain and soil resistant. Passes anti-bacterial AATCC 147-2011 solvent free.

Fire Retardancy: California technical bulletin 117 section-e. UFAC class 1.

Mildew: Product is mildew resistant.

Protective Finish: Antistain Endurepel Armour

Seam Slippage: Passes seam slippage ASTM-D751 w 149 x f 105 lb.

Tear Strength: Passes ASTM D2261 warp 7 lbs, fill 4 lbs. Passes ASTM D5733 warp 6 lbs, fill 4 lbs. Passes ASTM D751 warp 3.1kgf/7.6 cm, fill 1.9kgf/7.6cm

Tensile Strength; Passes ASTM D751 warp 38 lbs, fill 26 lbs.

Thickness: Product is .9 mm.

Ultraviolet: Lightfastness is 200 hours. Colorfastness to light AATCC16 Class 4.5.

Weight: 13.45 oz/sq. yd, 20.17 oz/yd.

Premier



84 Earth



87 Chestnut



95 Quicksilver

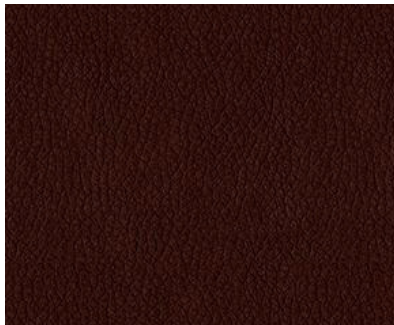

108 Wine



205 Sprig

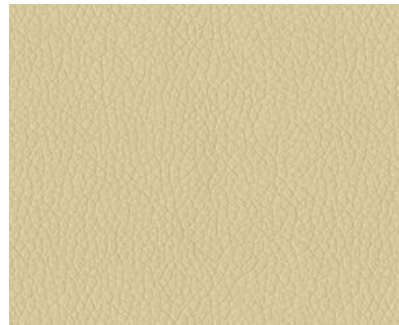

605 Parchment



608 Sandstone



802 Tan

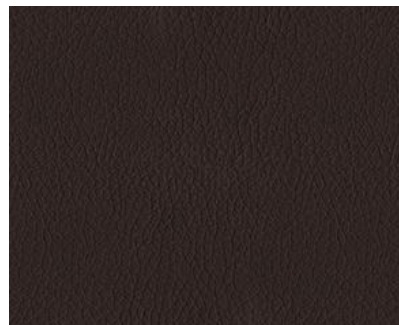

805 Bisque

Specifications

Width: 54"

Abrasion: Exceeds 500,000 double rubs

Backing Content: 15% cotton, 85% polyester

Cleaning Instruction: Mild soap and water. Dry immediately with a soft, dry cloth.

Cold Crack: Product cold crack is equal to or greater than -30 degrees celsius (-22 fahrenheit).

Content: 100% Polyurethane (PU)

Crocking: AATCC 8 dry class 5, wet class 5

Elongation: ASTM D751 warp 14.3%, fill 25.7%

Features: Passes ASTM G21-15 grade 1 wipe with a soft cloth, with cold water and a mild soap. Dry immediately. Hydrolysis pass 7 weeks (equal 7 years). Phthalates free, pvc free. Cleanable with Virox 5, PCS sodium hypochlorite disinfectant and Triad III if cleaning directions are followed and product is wiped completely dry after cleaning. Adhesion of coating ASTM D751 section 45-48 warp = 11.2/lb in and weft = 6.04 lb/in. REACH compliant, prop 65 compliant. Stain and soil resistant. Passes anti-bacterial AATCC 147-2011 solvent free.

Fire Retardancy: California technical bulletin 117 section-e. UFAC class 1.

Mildew: Product is mildew resistant.

Protective Finish: Antistain Endurepel Armour

Seam Slippage: Passes seam slippage ASTM-D751 w 149 x f 105 lb.

Tear Strength: Passes ASTM D2261 warp 7 lbs, fill 4 lbs. Passes ASTM D5733 warp 6 lbs, fill 4 lbs. Passes ASTM D751 warp 3.1kgf/7.6 cm, fill 1.9kgf/7.6cm

Tensile Strength: Passes ASTM D751 warp 38 lbs, fill 26 lbs.

Thickness: Product is .9 mm.

Ultraviolet: Lightfastness is 200 hours. Colorfastness to light AATCC16 Class 4.5.

Weight: 13.45 oz/sq. yd, 20.17 oz/yd.

Premier



808 Mocha



905 Steel



1009 Plum



3003 Pacific Blue



3006 Navy



3822 White



3948 Taupe



6003 Cream



6009 Chinchilla

Specifications

Width: 54"

Abrasion: Exceeds 500,000 double rubs

Backing Content: 15% cotton, 85% polyester

Cleaning Instruction: Mild soap and water. Dry immediately with a soft, dry cloth.

Cold Crack: Product cold crack is equal to or greater than -30 degrees celsius (-22 fahrenheit).

Content: 100% Polyurethane (PU)

Crocking: AATCC 8 dry class 5, wet class 5

Elongation: ASTM D751 warp 14.3%, fill 25.7%

Features: Passes ASTM G21-15 grade 1 wipe with a soft cloth, with cold water and a mild soap. Dry immediately. Hydrolysis pass 7 weeks (equal 7 years). Phthalates free, pvc free. Cleanable with Virox 5, PCS sodium hypochlorite disinfectant and Triad III if cleaning directions are followed and product is wiped completely dry after cleaning. Adhesion of coating ASTM D751 section 45-48 warp = 11.2/lb in and weft = 6.04 lb/in. REACH compliant, prop 65 compliant. Stain and soil resistant. Passes anti-bacterial AATCC 147-2011 solvent free.

Fire Retardancy: California technical bulletin 117 section-e. UFAC class 1.

Mildew: Product is mildew resistant.

Protective Finish: Antistain Endurepel Armour

Seam Slippage: Passes seam slippage ASTM-D751 w 149 x f 105 lb.

Tear Strength: Passes ASTM D2261 warp 7 lbs, fill 4 lbs. Passes ASTM D5733 warp 6 lbs, fill 4 lbs. Passes ASTM D751 warp 3.1kgf/7.6 cm, fill 1.9kgf/7.6cm

Tensile Strength: Passes ASTM D751 warp 38 lbs, fill 26 lbs.

Thickness: Product is .9 mm.

Ultraviolet: Lightfastness is 200 hours. Colorfastness to light AATCC16 Class 4.5.

Weight: 13.45 oz/sq. yd, 20.17 oz/yd.

Premier



8020 Chocolate



9003 Grey



9009 Black

Specifications

Width: 54"

Abrasion: Exceeds 500,000 double rubs

Backing Content: 15% cotton, 85% polyester

Cleaning Instruction: Mild soap and water. Dry immediately with a soft, dry cloth.

Cold Crack: Product cold crack is equal to or greater than -30 degrees celsius (-22 fahrenheit).

Content: 100% Polyurethane (PU)

Crocking: AATCC 8 dry class 5, wet class 5

Elongation: ASTM D751 warp 14.3%, fill 25.7%

Features: Passes ASTM G21-15 grade 1 wipe with a soft cloth, with cold water and a mild soap. Dry immediately. Hydrolysis pass 7 weeks (equal 7 years). Phthalates free, pvc free. Cleanable with Virox 5, PCS sodium hypochlorite disinfectant and Triad III if cleaning directions are followed and product is wiped completely dry after cleaning. Adhesion of coating ASTM D751 section 45-48 warp = 11.2/lb in and weft = 6.04 lb/in. REACH compliant, prop 65 compliant. Stain and soil resistant. Passes anti-bacterial AATCC 147-2011 solvent free.

Fire Retardancy: California technical bulletin 117 section-e. UFAC class 1.

Mildew: Product is mildew resistant.

Protective Finish: Antistain Endurepel Armour

Seam Slippage: Passes seam slippage ASTM-D751 w 149 x f 105 lb.

Tear Strength: Passes ASTM D2261 warp 7 lbs, fill 4 lbs. Passes ASTM D5733 warp 6 lbs, fill 4 lbs. Passes ASTM D751 warp 3.1kgf/7.6 cm, fill 1.9kgf/7.6cm

Tensile Strength; Passes ASTM D751 warp 38 lbs, fill 26 lbs.

Thickness: Product is .9 mm.

Ultraviolet: Lightfastness is 200 hours. Colorfastness to light AATCC16 Class 4.5.

Weight: 13.45 oz/sq. yd, 20.17 oz/yd.

Turner



11 Brick



14 Rust



17 Garnet



37 Lagoon



54 Citron

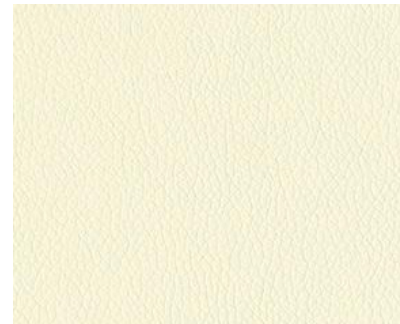

61 Vanilla



84 Earth

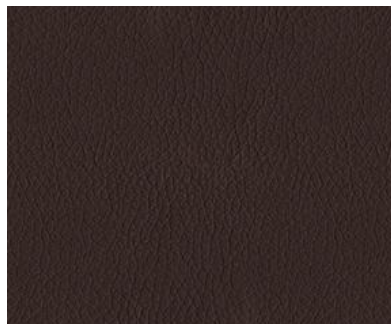

87 Chestnut



95 Quicksilver

Specifications

Width: 54"

Abrasion: Exceeds 500,000 double rubs.

Backing Content: 30% cotton, 70% polyester

Cleaning Instruction: Mild soap and water. Dry immediately with a soft, dry cloth.

Cold Crack: Product cold crack is equal to or greater than -40 degrees celsius (-40 fahrenheit).

Content: 100% Polyurethane (PU)

Crocking: AATCC 8 dry class 5, wet class 5

Elongation: ASTM D5034 warp 23.4%, fill 38.1%

Features: Wipe with a soft cloth, with cold water and a mild soap. Dry immediately. Adhesion of coating ASTM D571 section 45-48 warp = 7.34 lb/in and weft = 5.06 lb/in. Phthalate free. Hydrolysis pass 5 weeks (equal to 5 years). PVC free.

Fire Retardancy: California bulletin 117-section e. UFAC class 1

Seam Slippage: Passes seam slippage ASTM-D751 w 116 x f 90 lb.

Tear Strength: Passes ASTM D2261 - warp 20 lbs, fill 12 lbs.

Tensile Strength: Passes ASTM D5034 - warp 105 lbs, fill 74 lbs.

Ultraviolet: Colorfastness to light AATCC16 class 4.5

Weight: 15.33 oz/sq yd, 23.00 oz/linear yd.

Turner



108 Wine



205 Sprig



605 Parchment



608 Sandstone



802 Tan



805 Bisque



808 Mocha

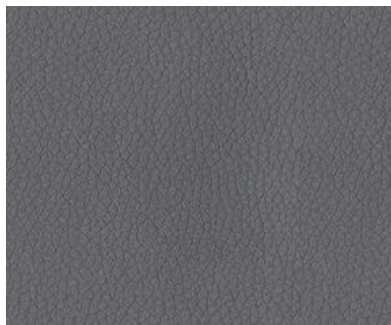

905 Steel



1009 Plum

Specifications

Width: 54"

Abrasion: Exceeds 500,000 double rubs.

Backing Content: 30% cotton, 70% polyester

Cleaning Instruction: Mild soap and water. Dry immediately with a soft, dry cloth.

Cold Crack: Product cold crack is equal to or greater than -40 degrees celsius (-40 fahrenheit).

Content: 100% Polyurethane (PU)

Crocking: AATCC 8 dry class 5, wet class 5

Elongation: ASTM D5034 warp 23.4%, fill 38.1%

Features: Wipe with a soft cloth, with cold water and a mild soap. Dry immediately. Adhesion of coating ASTM D571 section 45-48 warp = 7.34 lb/in and weft = 5.06 lb/in. Phthalate free. Hydrolysis pass 5 weeks (equal to 5 years). PVC free.

Fire Retardancy: California bulletin 117-section e. UFAC class 1

Seam Slippage: Passes seam slippage ASTM-D751 w 116 x f 90 lb.

Tear Strength: Passes ASTM D2261 - warp 20 lbs, fill 12 lbs.

Tensile Strength: Passes ASTM D5034 - warp 105 lbs, fill 74 lbs.

Ultraviolet: Colorfastness to light AATCC16 class 4.5

Weight: 15.33 oz/sq yd, 23.00 oz/linear yd.

Turner



3003 Pacific Blue



3006 Navy



3822 White



3948 Taupe



6003 Cream



6009 Chinchilla



8020 Chocolate



9003 Grey

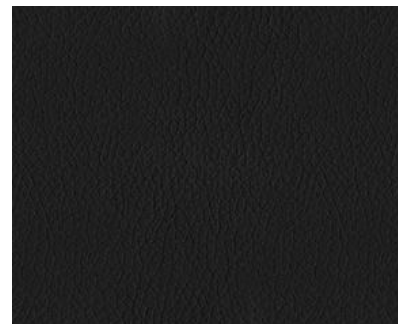

9009 Black

Specifications

Width: 54"

Abrasion: Exceeds 500,000 double rubs.

Backing Content: 30% cotton, 70% polyester

Cleaning Instruction: Mild soap and water. Dry immediately with a soft, dry cloth.

Cold Crack: Product cold crack is equal to or greater than -40 degrees celsius (-40 fahrenheit).

Content: 100% Polyurethane (PU)

Crocking: AATCC 8 dry class 5, wet class 5

Elongation: ASTM D5034 warp 23.4%, fill 38.1%

Features: Wipe with a soft cloth, with cold water and a mild soap. Dry immediately. Adhesion of coating ASTM D571 section 45-48 warp = 7.34 lb/in and weft = 5.06 lb/in. Phthalate free. Hydrolysis pass 5 weeks (equal to 5 years). PVC free.

Fire Retardancy: California bulletin 117-section e. UFAC class 1

Seam Slippage: Passes seam slippage ASTM-D751 w 116 x f 90 lb.

Tear Strength: Passes ASTM D2261 - warp 20 lbs, fill 12 lbs.

Tensile Strength: Passes ASTM D5034 - warp 105 lbs, fill 74 lbs.

Ultraviolet: Colorfastness to light AATCC16 class 4.5

Weight: 15.33 oz/sq yd, 23.00 oz/linear yd.

Casablanca

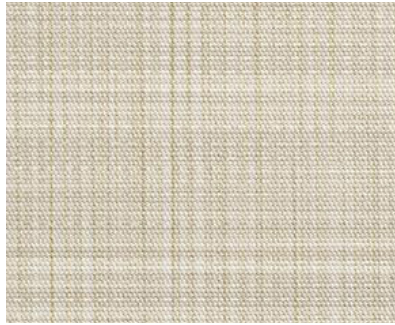

80 Dune



81 Moroccan Sand

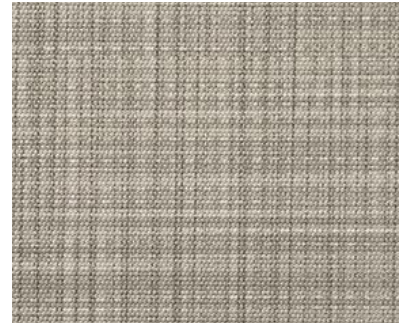

82 Tunisian Gray



83 Cafe

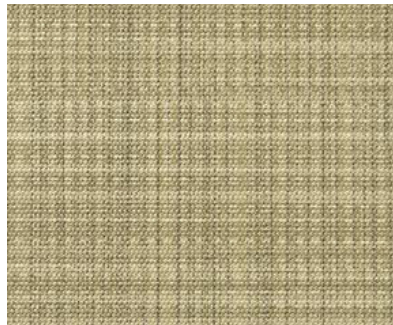

84 Palm

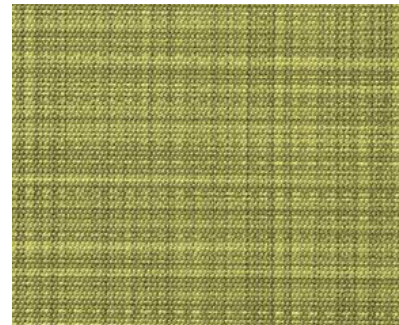

85 Avocado

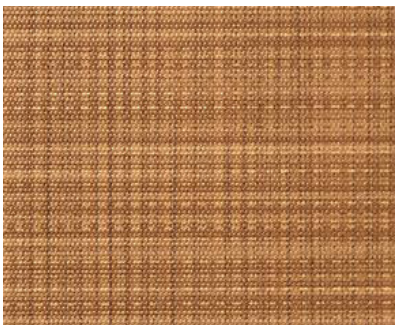

86 Sienna

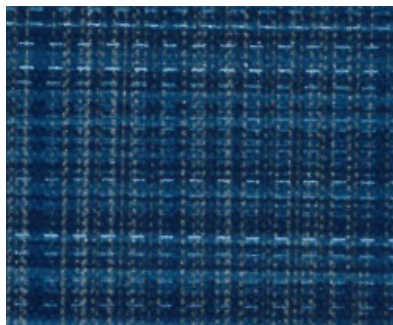

87 Sapphire



88 Syrah

Specifications

Width: 54"

Abrasion: Exceeds 250,000 double rubs

Backing Content: 100% Polyester

Cleaning Instruction: Mild soap and water. Dry immediately with a soft, dry cloth.

Cold Crack: Product cold crack is equal to or greater than -28 degrees celsius (-18 fahrenheit)

Content: 100% Polyvinyl chloride (PVC)

Crocking: AATCC 8: dry class 4.5, wet class 4.5

Features: Contains agents to protect against bacterial and fungal microorganisms. Sulfide stain resistant, oil resistant, mildew resistant, ultraviolet stable pigment, static dissipative. Advanced BeautyGard formulated for disinfectability with disinfectant products containing sodium hypochlorite (common household bleach) diluted 1:10.

Fire Retardancy: BIFMA class 1, Boston fire code 9-x11, California technical bulletin 117 section e

Protective Finish: Beauty Guard

Tear Strength: Passes ASTM D117 - warp = 12 lbs and fill = 10 lbs

Weight: 19.33 oz/sq yd, 29.00 oz/linear yd.

Casablanca

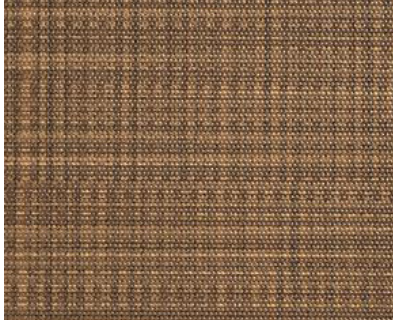

89 Java

Specifications

Width: 54"

Abrasion: Exceeds 250,000 double rubs

Backing Content: 100% Polyester

Cleaning Instruction: Mild soap and water. Dry immediately with a soft, dry cloth.

Cold Crack: Product cold crack is equal to or greater than -28 degrees celsius (-18 fahrenheit)

Content: 100% Polyvinyl chloride (PVC)

Crocking: AATCC 8: dry class 4.5, wet class 4.5

Features: Contains agents to protect against bacterial and fungal microorganisms. Sulfide stain resistant, oil resistant, mildew resistant, ultraviolet stable pigment, static dissipative. Advanced BeautyGard formulated for disinfectibility with disinfectant products containing sodium hypochlorite (common household bleach) diluted 1:10.

Fire Retardancy: BIFMA class 1, Boston fire code 9-x11, California technical bulletin 117 section e

Protective Finish: Beauty Guard

Tear Strength: Passes ASTM D117 - warp = 12 lbs and fill = 10 lbs

Weight: 19.33 oz/sq yd, 29.00 oz/linear yd.

Quarry



Apricot

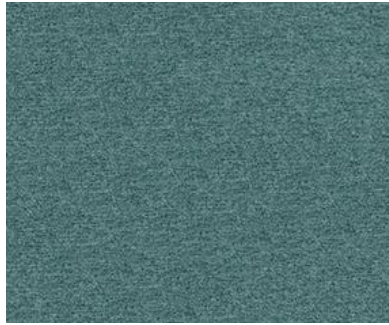

Aspen



Burlap



Delft



Denim



Fern



Gray



Gunmetal



Java

Specifications

Width: 57"

Abrasion: Exceeds 105,000 double rubs

Backing Content: 100% Polyester

Cleaning Instruction: SW-Clean with water-based cleaning agents (foam or pure).

Content: 100% Polyester

Fire Retardancy: California technical bulletin 117 section-e 2013, NFPA 260 class 1.

Pilling: Passes ASTM D3512 class 4

Seam Slippage: Passes ASTM D4034. F102 x W62 lbf.

Tear Strength: Passes ASTM D1424 - warp 25 lbs, fill 14 lbs.

Tensile Strength: Passes ASTM D5034 - warp 278 lbs, fill 74 lbs.

Ultra Violet: Colorfastness to light.

Weight: 12.00 oz/sq yd, 19.02 oz/linear yd.

Quarry



Leaf



Marigold

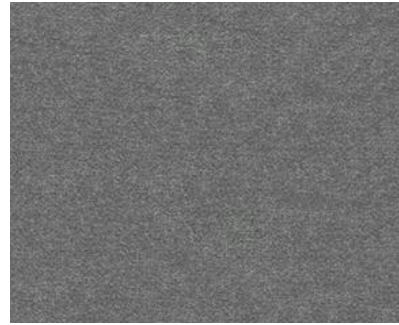

Nickel



Nutmeg



Onyx



Rose



Sand

Specifications

Width: 57"

Abrasion: Exceeds 105,000 double rubs

Backing Content: 100% Polyester

Cleaning Instruction: SW-Clean with water-based cleaning agents (foam or pure).

Content: 100% Polyester

Fire Retardancy: California technical bulletin 117 section-e 2013, NFPA 260 class 1.

Pilling: Passes ASTM D3512 class 4

Seam Slippage: Passes ASTM D4034. F102 x W62 lbf.

Tear Strength: Passes ASTM D1424 - warp 25 lbs, fill 14 lbs.

Tensile Strength: Passes ASTM D5034 - warp 278 lbs, fill 74 lbs.

Ultra Violet: Colorfastness to light.

Weight: 12.00 oz/sq yd, 19.02 oz/linear yd.

Surrey

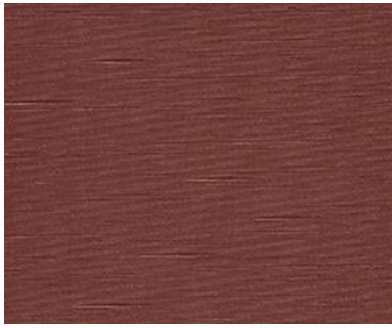

Aged Teak



Bear Hug



Birds Nest



Budding Fern

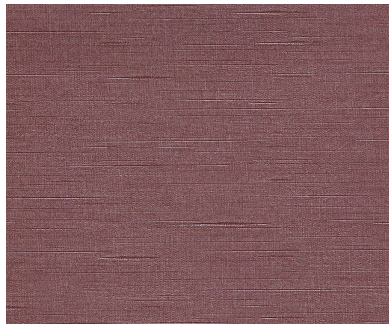

Dusty Plum



Exotic Escape

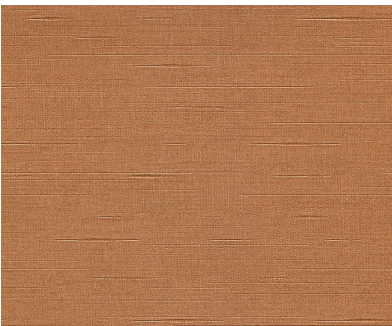

Fall Canyon

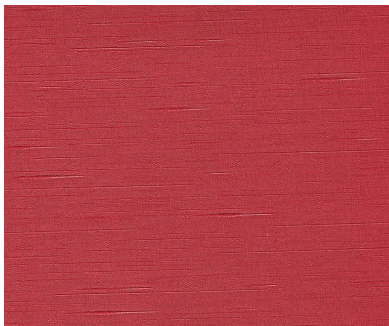

Fire Coral



Garden Gate

Specifications

Width: 54"

Abrasion: Exceeds 100,000 double rubs

Backing Content: 100% Polyester

Cleaning Instruction: Mild soap and water. Dry immediately with a soft, dry cloth.

Cold Crack: Product cold crack is equal to or greater than -10 degrees celsius (+4 farenheit)

Content: 100% Polyvinyl chloride (PVC)

Features: Anti-microbial/anti-bacterial. Product has been treated with anti-bacterial and anti-microbial agents that will provide resistance to the following: (AATCC test method 147-1993). Bacillus Mycoides, Klebsiella Pneumoniae, Proteus Vulgaris, Staphylococcus Aureus, Salmonella Choleraesuis, Bacillus Cerus, Enterococcus Faecalis, Eschrichia Coli.

Fire Retardancy: BIFMA class 1. California technical bulletin 117 section-e 2013. NFPA 260 class 1. UFAC class 1.

Protective Finish: Produratect C top finish

Thickness: Product thickness is 1.0mm

Ultraviolet: Product is rated ultraviolet resistant equal to or greater than 500 hours.

Weight: 18.64 oz/sq yd, 27.96 oz/linear yd.

Surrey



Gray Spell



Hi Def Lime

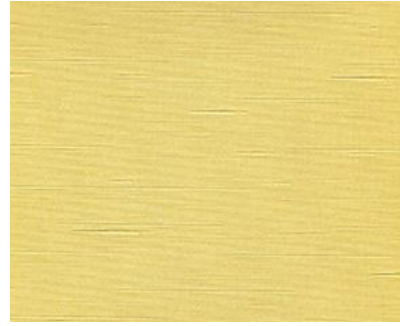

Lemon Splash



Mermaid Tail



North Rim

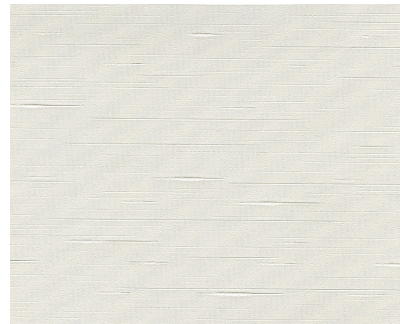

Origami



Palomino

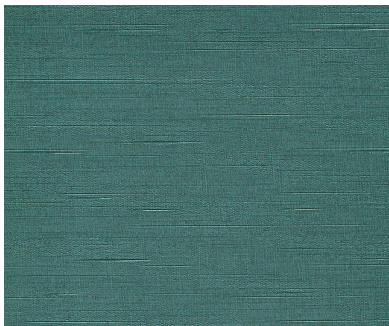

Prismatic Spring



Rain Dance

Specifications

Width: 54"

Abrasion: Exceeds 100,000 double rubs

Backing Content: 100% Polyester

Cleaning Instruction: Mild soap and water. Dry immediately with a soft, dry cloth.

Cold Crack: Product cold crack is equal to or greater than -10 degrees celsius (+4 fahrenheit)

Content: 100% Polyvinyl chloride (PVC)

Features: Anti-microbial/anti-bacterial. Product has been treated with anti-bacterial and anti-microbial agents that will provide resistance to the following: (AATCC test method 147-1993). Bacillus Mycoides, Klebsiella Pneumoniae, Proteus Vulgaris, Staphylococcus Aureus, Salmonella Choleraesuis, Bacillus Cerus, Enterococcus Faecalis, Eschrichia Coli.

Fire Retardancy: BIFMA class 1. California technical bulletin 117 section-e 2013. NFPA 260 class 1. UFAC class 1.

Protective Finish: Produratect C top finish

Thickness: Product thickness is 1.0mm

Ultraviolet: Product is rated ultraviolet resistant equal to or greater than 500 hours.

Weight: 18.64 oz/sq yd, 27.96 oz/linear yd.

Surrey

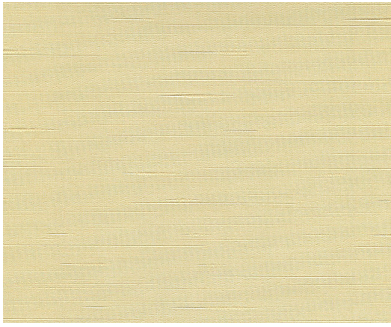

Sun Kissed

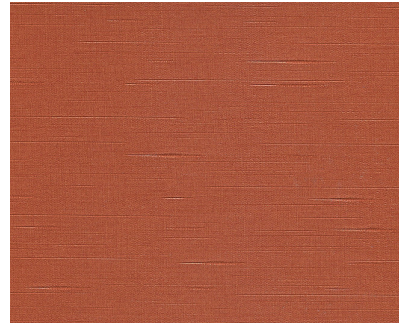

Tiger Mouth

Specifications

Width: 54"

Abrasion: Exceeds 100,000 double rubs

Backing Content: 100% Polyester

Cleaning Instruction: Mild soap and water. Dry immediately with a soft, dry cloth.

Cold Crack: Product cold crack is equal to or greater than -10 degrees celsius (+4 fahrenheit)

Content: 100% Polyvinyl chloride (PVC)

Features: Anti-microbial/anti-bacterial. Product has been treated with anti-bacterial and anti-microbial agents that will provide resistance to the following: (AATCC test method 147-1993).

Bacillus

Mycooides, Klebsiella Pneumoniae, Proteus Vulgaris, Staphylococcus Aureus, Salmonella Choleraesuis, Bacillus Cerus, Enterococcus Faecalis, Eschrichia Coli.

Fire Retardancy: BIFMA class 1. California technical bulletin 117 section-e 2013. NFPA 260 class 1. UFAC class 1.

Protective Finish: Produratect C top finish

Thickness: Product thickness is 1.0mm

Ultraviolet: Product is rated ultraviolet resistant equal to or greater than 500 hours.

Weight: 18.64 oz/sq yd, 27.96 oz/linear yd.

Tradewinds Plus



Abyss



Aleutian



Arctic Frost



Azure



Bahama

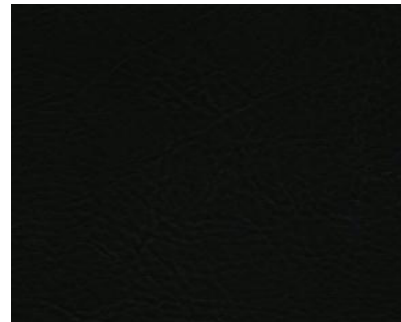

Black Sea



Carnival

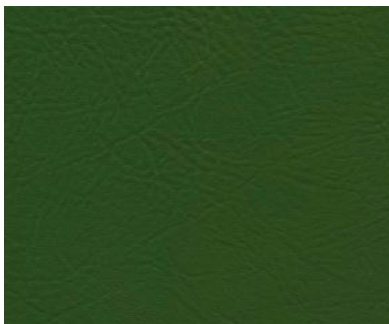

Cascade Pine

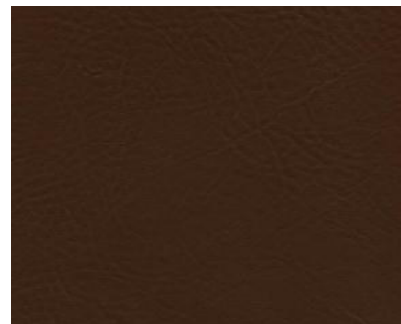

Coconut Bark

Specifications

Width: 54"

Abrasion: Exceeds 100,000 double rubs

Backing Content: 100% Polyester

Cold Crack: Product cold crack is equal to or greater than -23 degrees celsius (-10 fahrenheit).

Content: 100% Polyvinyl chloride (PVC)

Features: Product has been treated with anti-bacterial & anti-microbial agents that will provide resistance to the following: (AATCC test method 147) Bacillus Mycoides, Klebsiella Pneumoniae, Proteus Vugaris, Enterococcus Faecalis, Straphylococcus Aureus, Salmonella Choleraesuis, Bacillus Cerus, Escherichia Coli.

Fire Retardancy: California bulletin 117 section-3.

Thickness: Product thickness is 1.0 mm

Ultraviolet: Product is rated ultraviolet resistant equal to or greater than 500 hours.

Weight: 21.33 oz/sq yd, 32.00 oz/linear yd.

Tradewinds Plus



Costal Sand



Deep Lagoon



Deep Suntan

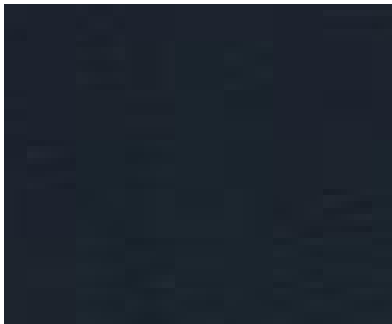

Delta Blue



Dolphin



Harbor Gray



Hawaiian Red



Ivory Coast

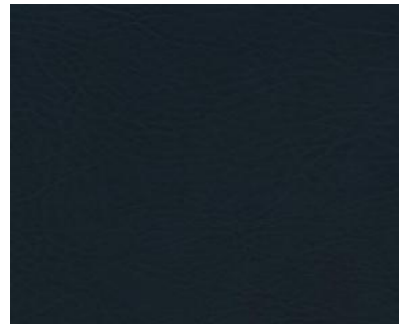

Midnight Surf

Specifications

Width: 54"

Abrasion: Exceeds 100,000 double rubs

Backing Content: 100% Polyester

Cold Crack: Product cold crack is equal to or greater than -23 degrees celsius (-10 fahrenheit).

Content: 100% Polyvinyl chloride (PVC)

Features: Product has been treated with anti-bacterial & anti-microbial agents that will provide resistance to the following: (AATCC test method 147) Bacillus Mycoides, Klebsiella Pneumoniae, Proteus Vugaris, Enterococcus Faecalis, Straphylococcus Aureus, Salmonella Choleraesuis, Bacillus Cerus, Escherichia Coli.

Fire Retardancy: California bulletin 117 section-3.

Thickness: Product thickness is 1.0 mm

Ultraviolet: Product is rated ultraviolet resistant equal to or greater than 500 hours.

Weight: 21.33 oz/sq yd, 32.00 oz/linear yd.

Tradewinds Plus



Moonmisty



Pacific Mist



Pearl



Polar Dusk

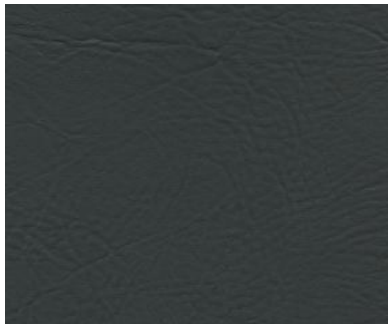

Porpoise

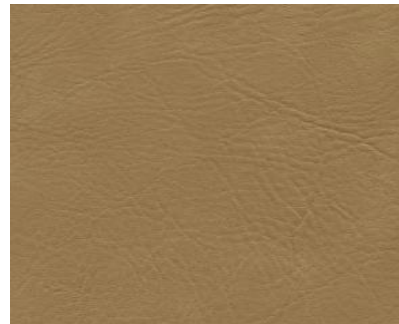

Sand Point

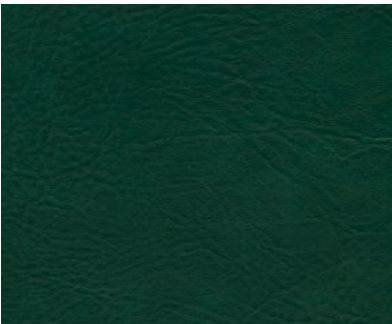

Sea Frost



Sea Shell



Stormy

Specifications

Width: 54"

Abrasion: Exceeds 100,000 double rubs

Backing Content: 100% Polyester

Cold Crack: Product cold crack is equal to or greater than -23 degrees celsius (-10 fahrenheit).

Content: 100% Polyvinyl chloride (PVC)

Features: Product has been treated with anti-bacterial & anti-microbial agents that will provide resistance to the following: (AATCC test method 147) Bacillus Mycoides, Klebsiella Pneumoniae, Proteus Vugaris, Enterococcus Faecalis, Straphylococcus Aureus, Salmonella Choleraesuis, Bacillus Cerus, Escherichia Coli.

Fire Retardancy: California bulletin 117 section-3.

Thickness: Product thickness is 1.0 mm

Ultraviolet: Product is rated ultraviolet resistant equal to or greater than 500 hours.

Weight: 21.33 oz/sq yd, 32.00 oz/linear yd.

Tradewinds Plus



Sunset Red

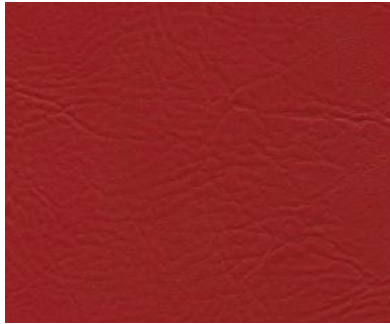

Tropical Punch



Ultra White

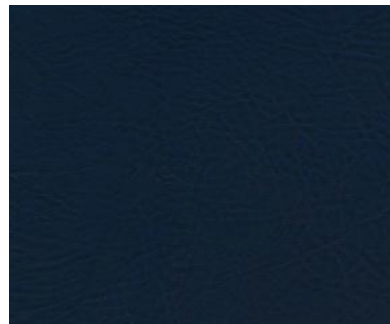

Ultra Marine

Specifications

Width: 54"

Abrasion: Exceeds 100,000 double rubs

Backing Content: 100% Polyester

Cold Crack: Product cold crack is equal to or greater than -23 degrees celsius (-10 fahrenheit).

Content: 100% Polyvinyl chloride (PVC)

Features: Product has been treated with anti-bacterial & anti-microbial agents that will provide resistance to the following: (AATCC test method 147) Bacillus Mycoides, Klebsiella Pneumoniae, Proteus Vugaris, Enterococcus Faecalis, Straphylococcus Aureus, Salmonella Choleraesuis, Bacillus Cerus, Escherichia Coli.

Fire Retardancy: California bulletin 117 section-3.

Thickness: Product thickness is 1.0 mm

Ultraviolet: Product is rated ultraviolet resistant equal to or greater than 500 hours.

Weight: 21.33 oz/sq yd, 32.00 oz/linear yd.

Windsong 2

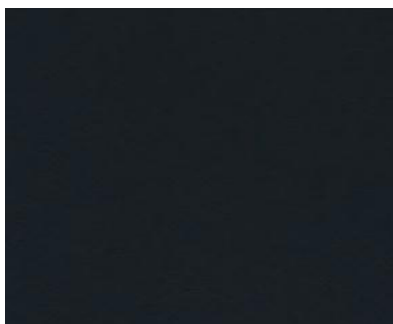

Alaskan Night



Baja Tan



Cajun Spice



Cappuccino

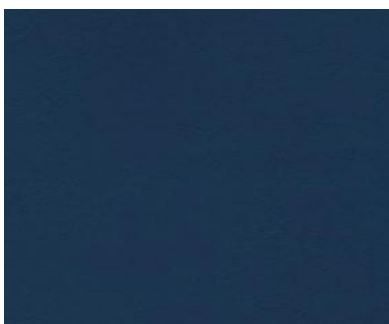

Cayman Blue



Cloud



Fog

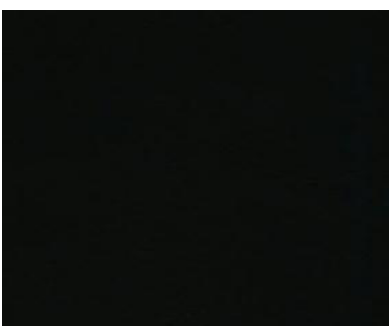

Hurricane Black



Ice Water

Specifications

Width: 54"

Abrasion: Exceeds 100,000 double rubs

Backing Content: 100% Polyester

Cleaning Instruction: Mild soap and water.

Cold Crack: Product cold crack is equal to or greater than -23 degrees celsius (-10 fahrenheit).

Content: 100% Polyvinyl chloride (PVC)

Features: Product has been treated with anti-bacterial & anti-microbial agents that will provide resistance to the following: (AATCC test method 147) Bacillus Mycoides, Klebsiella Pneumoniae, Proteus Vugaris, Enterococcus Faecalis, Straphylococcus Aureus, Salmonella Choleraesuis, Bacillus Cerus, Escherichia Coli.

Fire Retardancy: California bulletin 117 section-3.

Thickness: Product thickness is 1.0 mm

Ultraviolet: Product is rated ultraviolet resistant equal to or greater than 500 hours.

Weight: 21.33 oz/sq yd, 32.00 oz/linear yd.

Windsong 2



Ink



Lipstick

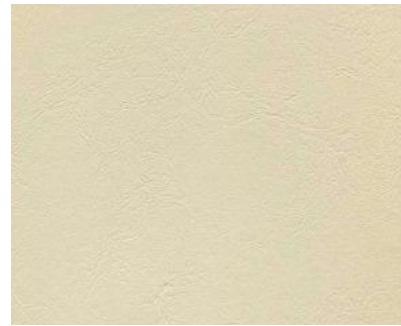

Malibu Sand

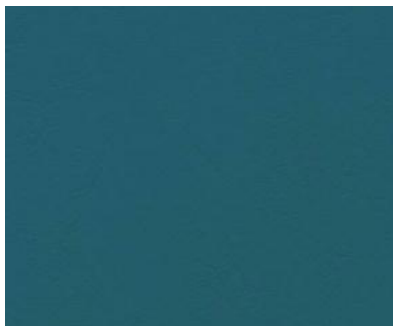

Marine Blue



Maui Sand



Moonbeam



Nautical Blue

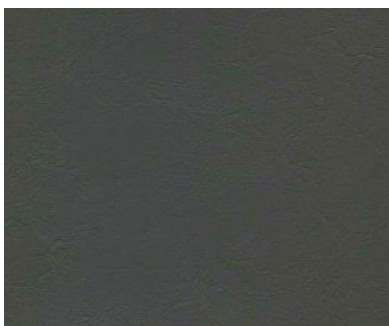

Ocean Storm



Palm Green

Specifications

Width: 54"

Abrasion: Exceeds 100,000 double rubs

Backing Content: 100% Polyester

Cleaning Instruction: Mild soap and water.

Cold Crack: Product cold crack is equal to or greater than -23 degrees celsius (-10 fahrenheit).

Content: 100% Polyvinyl chloride (PVC)

Features: Product has been treated with anti-bacterial & anti-microbial agents that will provide resistance to the following: (AATCC test method 147) Bacillus Mycoides, Klebsiella Pneumoniae, Proteus Vugaris, Enterococcus Faecalis, Straphylococcus Aureus, Salmonella Choleraesuis, Bacillus Cerus, Escherichia Coli.

Fire Retardancy: California bulletin 117 section-3.

Thickness: Product thickness is 1.0 mm

Ultraviolet: Product is rated ultraviolet resistant equal to or greater than 500 hours.

Weight: 21.33 oz/sq yd, 32.00 oz/linear yd.

Windsong 2

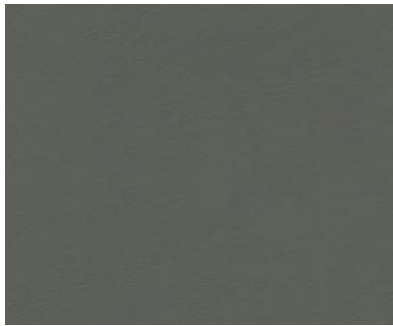

Pebble Beach



Pelican



Polar Breeze



Royal Red



Sea Salt



St. Thomas Dusk



Tahiti Reef

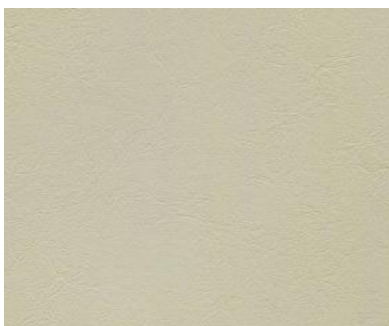

Vanilla Cream



Whitecap

Specifications

Width: 54"

Abrasion: Exceeds 100,000 double rubs

Backing Content: 100% Polyester

Cleaning Instruction: Mild soap and water.

Cold Crack: Product cold crack is equal to or greater than -23 degrees celsius (-10 fahrenheit).

Content: 100% Polyvinyl chloride (PVC)

Features: Product has been treated with anti-bacterial & anti-microbial agents that will provide resistance to the following: (AATCC test method 147) Bacillus Mycoides, Klebsiella Pneumoniae, Proteus Vugaris, Enterococcus Faecalis, Straphylococcus Aureus, Salmonella Choleraesuis, Bacillus Cerus, Escherichia Coli.

Fire Retardancy: California bulletin 117 section-3.

Thickness: Product thickness is 1.0 mm

Ultraviolet: Product is rated ultraviolet resistant equal to or greater than 500 hours.

Weight: 21.33 oz/sq yd, 32.00 oz/linear yd.

Wood Chair Frame Finishes

Choose Your Frame Finish For the Models Below:
HCH245, HCH184, HCH169, HCH168, HLC101, HLC109, HLC144,
HLC242, HLC236, HLC285, HLC147, HLC168,
HCH980, HLC720, HLC722, HCH4581, HCH1999

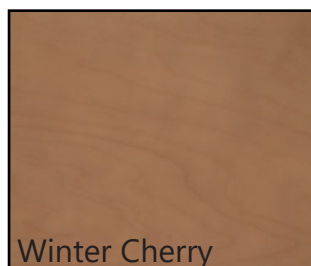
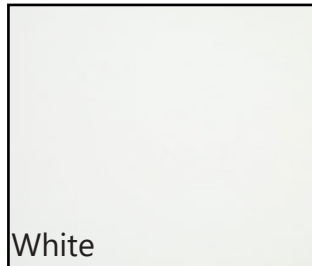
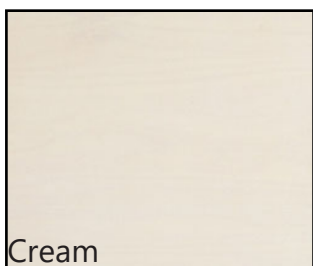
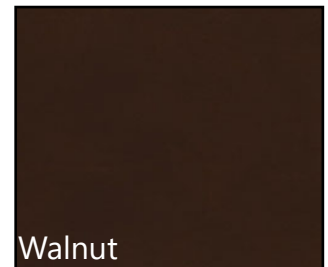
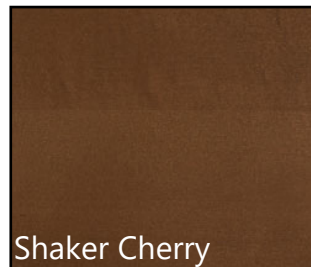
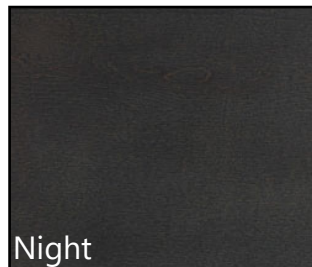
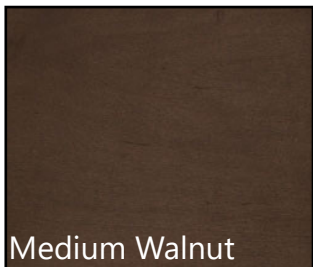
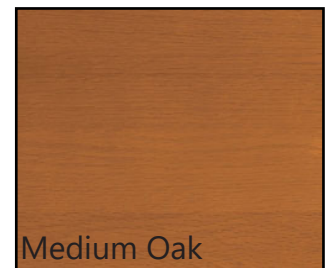
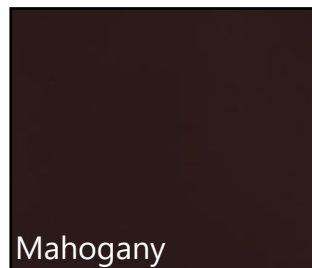
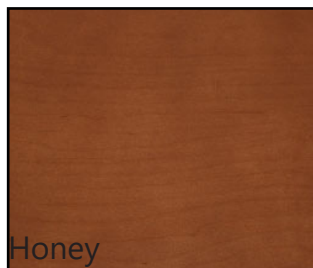
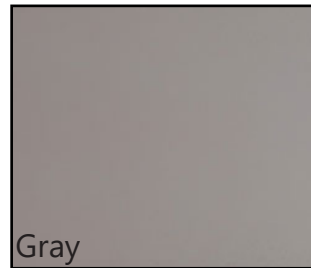
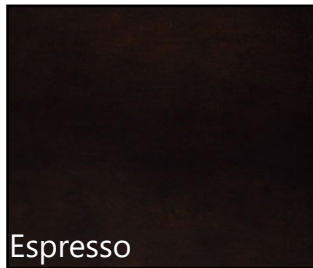
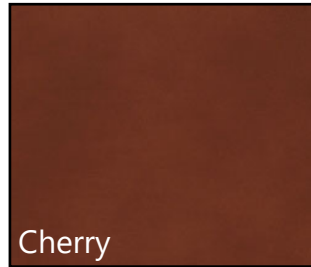
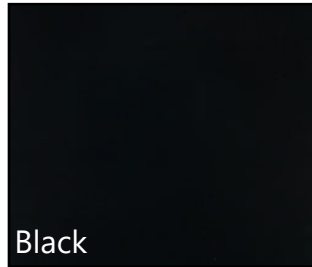
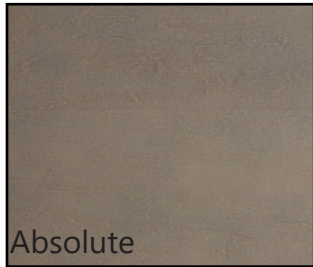

Wood Chair Frame Finishes

Choose Your Frame Finish For the Models Below:
HCH2042, HCH394, HCH395, HCH605, HLC26, HLC100

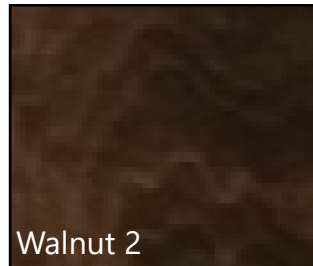
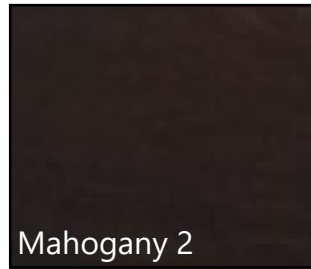
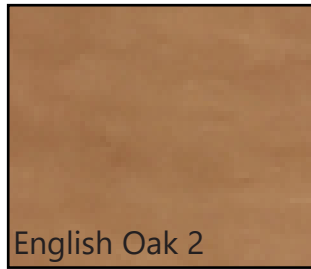
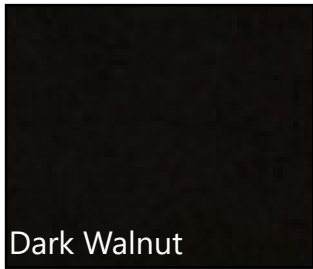

Aluminum Wood Look Chair Frame Finishes

Choose Your Frame Finish For the Models Below:
HCHM3850, HCHM3866, HCHM3728, HCHM3874, HCHM3854, HCHM3770,
HCHM3849, HCHM3772, HCHM3812, HCHM3736, HCHM3872, HCHM3864

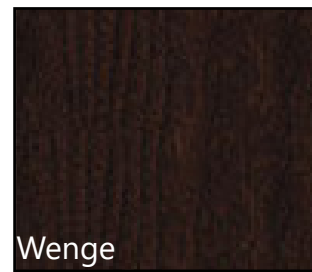
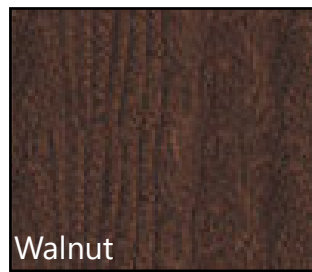
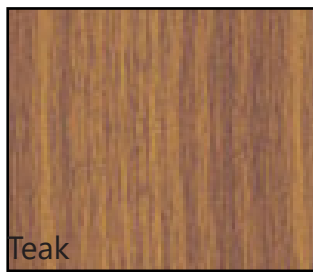
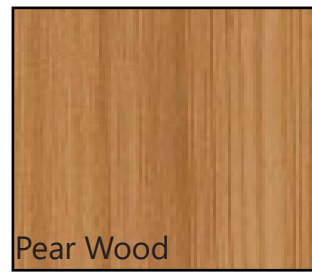
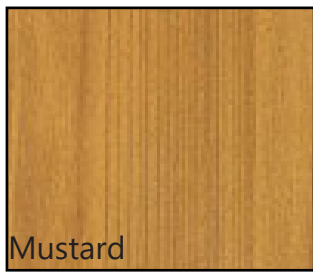
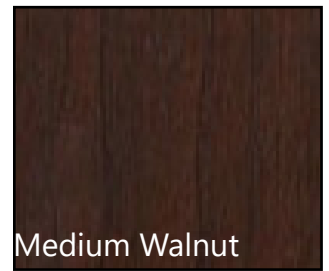
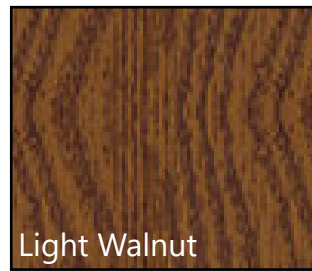

Intellicare Technology - Patient Lighting

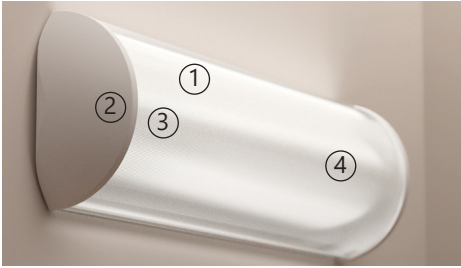

1. Prismatic Acrylic Lens
2. Gap Free Sealed Joints
3. Available with T8 or T5HO Lamps
(Sold Separately)
4. 2 Lamps



1. Prismatic Acrylic Lens
2. Gap Free Sealed Joints
3. Available with T8 or T5HO Lamps
(Sold Separately)
4. 3 Lamps

Lighting Construction

- Lamps: T8 (Sconce 17W, Wall Mount 32W), T5HO (Sconce 24W, Wall Mount 54W)
- Tight Seams for Quick Cleaning
- High-Efficiency Ballasts
- Durable Powder Coated Steel & Extruded Aluminum Construction
- No Integrated On-Board Switching Provided
- CSA, UL, ADA
- Wall Mount Bed Light Has 3-Circuits (Reading, Ambient, Exam) & 3 Bulbs. Sequence: Ambient, Reading, Both, Off.
- Wall Mount Bed Light Has the Option of a Pillow Switch with LV Controller.
- Sconce Has 1-Circuit & 2 Bulbs

Intellicare Technology Price List Patient Room Lighting



Wall Mounted LED Light (T8)		
Size	Code	List Price
48"	H/LED/48/T8	\$550

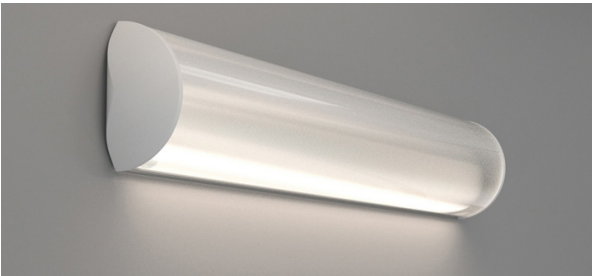

Wall Mounted LED Light (T5HO)		
Size	Code	List Price
48"	H/LED/48/T5/HO	\$670



Wall Mounted LED Light with LV Controller & Pillow Switch (T8)		
Size	Code	List Price
48"	H/LED/48/LVPS/T8	\$900



Wall Mounted LED Sconce (T8)		
Size	Code	List Price
16"	H/LED/SCONCE/T8	\$350



Wall Mounted LED Sconce (T5HO)		
Size	Code	List Price
16"	H/LED/SCONCE/T5/HO	\$400

***Lamps are not included**

Intellicare Technology Price List

Light Box

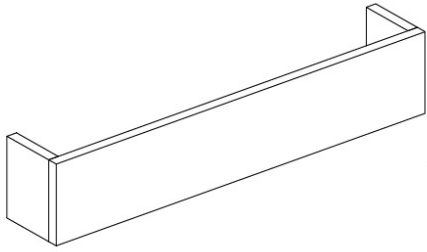

Laminate Light Box (7"D x 7"H)

Size	Code	List Price
24"W	H/LB/LAM/24	\$110
36"W	H/LB/LAM/36	\$120
42"W	H/LB/LAM/42	\$130
48"W	H/LB/LAM/48	\$140

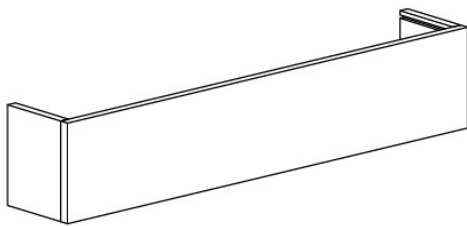

Thermofoil Light Box (7.5"D x 7.5"H)

Size	Code	List Price
39"W	H/LB/THER/NOGLS/39	\$265
51"W	H/LB/THER/NOGLS/51	\$320
39"W	H/LB/THER/GLS/39	\$440
51"W	H/LB/THER/GLS/51	\$635

* NOGLS denotes no glass on top and bottom, GLS denotes glass on top and bottom.

Intellicare Technology Price List

Technology Solutions



Single Monitor Mount (Compatible with VESA 75 & 100mm Brackets)

Size	Code	List Price
6"x6"	H/MM	\$395

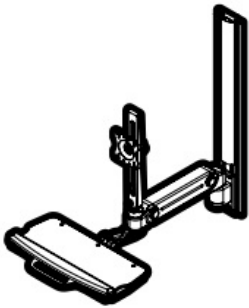

Compact Wall Rail Keyboard & Monitor Support

Size	Code	List Price
32"	H/WM/KB	\$2000



Mobile Laptop Cart

Size	Code	List Price
33.5"-45"	H/LAPTOPCART	\$2955



Digilock Digital RFID Lock *Factory Installed

Size	Code	List Price
5.8"x1.5"	DIGILOCK	\$550

Intellicare Technology Price List Technology Solutions



Numeris Digital RFID Lock *Factory Installed

Size	Code	List Price
5.7"x1.2"	NUMERISLOCK	\$350

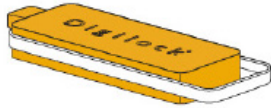

Digital RFID Programming Key

Code	List Price
PROGKEY	\$100



Manager Bypass Key

Code	List Price
BYPASSKEY	\$100



User Key

Code	List Price
USERKEY	\$100

Intellicare Mattress Specifications

Alden

- Tight Top
- 7" High
- 5 1/2" Bio Foam Core - 4" Hi-Density Bio Foam & 1 1/2" Convoluted Bio Foam
- Multi-Needle Quilted to 3/4" Super Soft Bio Foam, & 20 oz. Hollow Fibre

Charlotte

- Euro Top - Plush
- 9.5" High
- 720 Continuous Coil
- Insulator Pad
- 1 1/2" Convoluted Bio Foam
- Multi-Needle Quilted to 1/2" Bio Foam, & 20 oz. Hollow Fibre

Athletic

- Tight Top
- Two-Sided
- 10" High
- 800 Continuous Coil
- Foam Encased
- 1 1/2" Convoluted Bio Foam
- 3/4" Hi-Density Flexel Insulator Pad (2) & 1/2" Bio Foam (2)
- Multi-Needle Quilted to 1/2" Bio Foam

Health Care

- Two-Sided
- Tight Top - Luxury Firm
- 11.5" High
- 800 Zoned Comfort Pockets
- Foam Encased
- Fibre Insulator Pad
- 3/4" Bio Foam, 1/2" Trizone AquaGel Memory Foam (2)
- Tack & Jump Quilted to 3/4" Super Soft Bio Foam with Gel, and 20 oz. Hollow Fibre

Andrea

- Tight Top - Firm
- 6" High
- 5 1/2" Bio Foam Core - 4" Hi-Density Bio Foam & 1 1/2" Convoluted Bio Foam
- Multi-Needle Quilted to 1/2" Bio Foam

Athletic 7

- Tight Top
- Two-Sided
- 10" High
- 720 Zoned Comfort Pockets
- Fibre Insulator Pad
- 1/2" Bio Foam
- Multi-Needle Quilted to 1/2" Bio Foam

Intellicare Mattress Price List



Alden

Size	Code	List Price
Twin	HMAT-ALD/TWIN	\$415
Double	HMAT-ALD/DOUBLE	\$630
Queen	HMAT-ALD/QUEEN	\$725
King	HMAT-ALD/KING	\$1170



Charlotte

Size	Code	List Price
Twin	HMAT-CHA/TWIN	\$695
Double	HMAT-CHA/DOUBLE	\$855
Queen	HMAT-CHA/QUEEN	\$918
King	HMAT-CHA/KING	\$1412



Athletic

Size	Code	List Price
Twin	HMAT-ATH/TWIN	\$899
Double	HMAT-ATH/DOUBLE	\$1221
Queen	HMAT-ATH/QUEEN	\$1252
King	HMAT-ATH/KING	\$1878

Intellicare Mattress Price List



Health Care		
Size	Code	List Price
Twin	HMAT-HC/TWIN	\$783
Double	HMAT-HC/DOUBLE	\$1096
Queen	HMAT-HC/QUEEN	\$1196
King	HMAT-HC/KING	\$1612



Andrea		
Size	Code	List Price
Twin	HMAT-AND/TWIN	\$354
Double	HMAT-AND/DOUBLE	\$532
Queen	HMAT-AND/QUEEN	\$610
King	HMAT-AND/KING	\$845



Athletic 7		
Size	Code	List Price
Twin	HMAT-ATH7/TWIN	\$673
Double	HMAT-ATH7/DOUBLE	\$908
Queen	HMAT-ATH7/QUEEN	\$1002
King	HMAT-ATH7/KING	\$1277

Mattress Foundations:	Mattress Encasements:
Twin: List \$200	Twin: List \$130
Double: List \$240	Double: List \$155
Queen: List \$280	Queen: List \$170
King: List \$435	King: List \$205

Intellicare Specs

MADE IN CANADA

All products are manufactured on a per order basis, locally in Mississauga, Ontario. Our commitment to quality extends throughout the company's growing staff, cultivating a company culture of excellence we're proud of.

CUSTOM CAPABILITIES

Over half of the products manufactured by Intellicare are custom items not shown in our standard line. Intellicare is proud to offer this option, as well as dimensional changes on any standard item. Please contact your local representative for more details and pricing.

SCS INDOOR AIR QUALITY GOLD CERTIFICATION

Voluntarily testing that determines individual volatile organic compounds (VOC) emissions in a product. In addition to testing, audits of quality management procedures and the facility site are required to attain Gold certification.

1" COMMERCIAL TFL PANELS

High Density Thermally Fused Laminate is an extremely durable material with dozens of commercial applications. Intellicare uses an industry leading 1" thick TFL on all series back panels and sides; and all 100, 200, 400 & 500 series surfaces.

1" SEALED THERMOFORM TOPS

Heat Sealed Thermoform is spill-proof, seamless, moisture and humidity resistant and easy to clean. Comes standard on 100+, 200+ 500+ and 400 series tops, along with 400 series door and drawer faces. Thermoform is available in 4 standard top profiles and 6 front styles.

PRODUCT GLOSSARY

Slides:	Full Extension Steel Ball Bearing Slides. Each rated to 125 lbs weight capacity
Glides:	1/4" Thick Steel Levelling Glide with T-Nut Combination. Thread with a maximum height of 1.75"
Drawer Liner:	Spillproof Moulded Plastic Insert to protect drawer interiors
Locks:	Lock and Key set in chrome finish with 2 keys. Locks are available keyed alike and master keys are also available.
Coat Hook:	All metal with single upper and single lower hook. 3.5"x2.5"
Coat Rod:	1" Thick, 14 Gauge Metal Bar available up to 48" wide
Casters:	1.5" Wheel Diameter with swivel feature and optional brake. Each rated to 88lbs. Heavy Duty Nylon 3" Wheel Diameter with swivel feature and optional brake. Each rated to 220lbs. Medical Grade 3" Thermoplastic Rubber with swivel feature and optional brake. Each rated to 176lbs.

Intellicare Terms

PRICES

All prices are suggested retail. Prices are subject to change without notice. All descriptions, illustrations and prices in this book are based on the most up to date information at the time of printing. Every effort has been made to ensure accuracy through out the price list however, Intellicare reserves the right to modify or replace the item without notice.

TERMS

Orders are invoiced at time of completion date. Terms of payment are net 30 days from date of completion (subject to credit approval). The customer agrees that Intellicare shall have the right to enforce a charge amounting to 1.5% per month (18% per year) on invoices outstanding more than 30 days. Shall the buyer fail to fulfill the above mentioned terms of payment, Intellicare reserves the right to defer further shipments. Orders over \$5,000 net may be subject to longer lead times and a deposit. If dealer's most recent annual net volume is less than \$5,000, payment must be made in advance.

FREIGHT

All goods are sold F.O.B Intellicare Factory unless otherwise agreed upon in writing by the manufacturer. All shipments are arranged by Intellicare using dedicated office furniture logistic providers, and expected to deliver to a dock with the ability to handle a 53' trailer. Delivery beyond the dock, installation, and removal of packaging materials are all the responsibility of the customer and will not be covered by Intellicare. Drop shipments to site and timed deliveries and lift gate trucks are available. Please contact our logistics department for more details. Intellicare will provide customers with an anticipated day of delivery. Every effort is made to adhere to the prescribed delivery date, however, neither Intellicare nor the carrier will guarantee, or be held responsible in any manner for delays or deviation from the planned delivery date. Intellicare is not responsible for any costs incurred for late deliveries, including labor or other charges resulting from unforeseen delays.

OWNERSHIP OF GOODS

Intellicare or its agent will retain full ownership of the goods listed on invoices until the full amount is totally remitted. Since all goods must be ordered by an official purchase order showing the agreed terms and other pertinent details, the dealer distributor agrees to above conditions and would be responsible in a court of law for all expenses incurred by Intellicare to recover amounts due. This is understood as being part of the buying conditions.

COPYRIGHT

All catalogues, photographs, drawings, price lists and other printed material are protected by copyright. All rights reserved.

STORAGE

In the event the purchaser requests postponement of delivery / pick up beyond the acknowledgment completion date, Intellicare may transfer the goods to storage for the purchaser after 5 business days at the purchaser's risk and expense. Such transfer to storage shall be deemed delivery to purchaser for all purposes including invoicing and payment. All goods are payable from the date Intellicare has finished manufacturing.

CARE AND MAINTENANCE

Clean all surfaces and gables with mild soap and warm water. Do not use hot water or any abrasive cleaning products on the surface. Contact your local representative or visit our website for a more complete list of appropriate cleaning solutions.

REPLACEMENT PARTS & DEFICIENCIES

Requests for replacement parts or units must be sent in writing using our deficiency form. Please include pictures showing the deficiency. Replacement parts will be processed as a priority. Please consult with customer service for delivery lead time. Please note, we do not ship replacement parts or units to site or any other location other than the dealer's warehouse. Service requests are the responsibility of Intellicare's authorized dealers. Please refer all service problems to Intellicare customer service department.

DISCLAIMER

Prices shown are Intellicare's current list prices at the time of printing. All applicable taxes are extra. Descriptions, specifications and prices are subject to change without notice. Errors and omissions are subject to correction.

GOVERNING LAW

This contract shall be construed and governed in accordance with the laws of the province of Ontario, Canada. Intellicare Furniture is a division and brand of IOF Business Furniture.

Intellicare Warranty

LIFETIME WARRANTY

CASEGOOD WARRANTY

Intellicare warrants all products to be free from defects in material and workmanship for the life of the product to the original purchaser. Proof of delivery is the only official document accepted by Intellicare for any claim.

This warranty does not apply to any product which must be repaired or replaced due to nominal wear and tear, overuse, negligence, abuse, accident or the product has been modified by someone other than Intellicare or its authorized dealers, or without consent from Intellicare directly. The warranty will also not apply in cases of over-exposure to extreme heat and cold, and/or Sunlight and UV rays.

This warranty is made by Intellicare only to purchasers acquiring the product directly from Intellicare, its authorized dealers, and representatives. Products used for rental, leasing or similar actions are not covered in this warranty.

the following components are also covered under this warranty for a period beginning from the time of delivery.

Laminate Material 25 years

Thermoform Material 15 years

Moving Parts slides, casters and lock 5 years

Stationary parts like handles and brackets 10 years

High Impact Edging 10 years

Exclusions are Light Bulbs, Ballasts, Customers Own Material

SEATING WARRANTY

WOOD FRAMES - 2 YEAR LIMITED WARRANTY:

The frame which is made of kiln-dried hardwood is warranted to the original purchaser against manufacturing defects of the product for two years from purchase date - product upholstered in original fabric under normal use and conditions.

ALUMINUM FRAMES - 5 YEAR LIMITED WARRANTY:

The frame which is made of extruded aluminum is warranted to the original purchaser against manufacturing defects of the product for five years from purchase date - product upholstered in original fabric under normal use and conditions.

MECHANISMS - 1 YEAR LIMITED WARRANTY:

Recliner, swivel rocker, and sleeper mechanisms are warranted to be free of defects for one year from the date of purchase. One year parts and labour.

SPRINGS - 5 YEAR LIMITED WARRANTY:

Intellicare Furniture warrants to the original purchaser all springs to be free against breakage due to defective material or workmanship for a period of five years from the date of purchase.

FOAM - 2 YEAR LIMITED WARRANTY:

Intellicare Furniture products utilize high resiliency flame retardant foam in all its upholstered health care products and will warrant the seat foam for two years. The loss of resiliency should not be confused with slight softening and flattening of the polyester fibre and foam that will result from normal use and aging.

CRYPTON and VINYL WARRANTY:

Vinyl and Crypton warranties are dependant upon the mill which produces the product. Please refer to the manufacturer's website for information on warranties for fabrics.

WARRANTY SERVICE:

All claims for service must be made to the distributor where the product was purchased. The claim must be accompanied with the bill of sale. Intellicare Furniture will not be responsible for the packing, shipping or transportation costs from our facility and the distributor. Approval must be attained from the factory before the distributor can send products in for the proper repairs. Repairs will be made in a responsible time.

MAINTENANCE:

Proper maintenance is required for this warranty to remain valid. Contact your representative for approved maintenance practices. Inspections should be performed on a quarterly basis to maintain proper working condition.

Intellicare reserves the right to choose to repair or replace any claims and consent from Intellicare must be obtained before any warranty work is performed. Shipping costs of replacement parts, installation and downtime costs associated with warranty work to be the responsibility of Intellicare's authorized dealer/ representative. When repairing or replacing a defective product, Intellicare does not guarantee matching color, grain texture or dye lots. This warranty does not cover the cost of transportation or labor. Under no circumstances shall Intellicare be liable for accidental or consequential damages, or mishandling of the product. Nor will Intellicare accept responsibility in the case of mis-installation or transit damages or incorrectly ordered products and components. The above Intellicare warranty applies to products manufactured after January 1, 2006.

Intellicare Environmental Statement

Environmental Statement

At Intellicare we strive to be a good steward of our natural resources. Our efforts to reduce the environmental impact of our manufacturing processes are seen in many areas, most notably in the following

Wood Components:

Material is supplied by a FSC accredited vendor, meaning that wood is sourced from sustainable forests. Waste is shredded and used for animal bedding in the agricultural sector.

Metal Components:

All metal waste is recycled for re-use. The recyclable steel frames are finished in a lead free powder coat with zero VOC and solvents. Excess powder is reclaimed and re-used.

Foam:

There are no CFC's, adhesives or formaldehyde used in any of our polyurethane foam products including our renewable resource foam which is based on an agriculturally derived Polyol at 20% concentration. Intellicare primarily uses molded foam, virtually eliminating waste. Molded foam is created using a chemical reaction temperature as opposed to an external heat source. Waste from molded foam is supplied to a local pillow-stuffer, diverting it from a landfill site. Where cut foam is used, waste is sent back to the supplier who then recycles and converts it into carpet underlay.

Upholstery:

Intellicare promotes upholstery products that are produced from 100% recycled fibre, bio-based fibre or natural, compostable fibre upholstery.

Glue:

Intellicare only uses water-based adhesives that conform to environmental regulations.

Intellicare continues to explore environmentally friendly initiatives and pledge to utilize these initiatives in our manufacturing processes wherever possible



Intellicare

F U R N I T U R E

1710 Bonhill Rd. Mississauga, Ontario L5T 1C8
www.intellicarefurniture.com
info@intellicarefurniture.com
Telephone: 905-672-0942
Toll Free: 1-800-764-2392